



25 YEARS

PET

2025/2026



01.01.2000
operational start,
Storage in Eberstallzell
at the farm

11.2001
First sales representative is
trained from bricklayer to
salesman



03.2004
Wels:
First trade fair participation
at the Energiesparmesse

06.2003
First Trade mark
application

09.2003
1st trainee
starts the
apprenticeship

11.2004
China:
Herbert Ziegelbäck
makes the first
shopping trip to china



11.2004
Villach:
Opening of the
3rd PET location

Daniel Ziegelbäck joins the
family company



03.2011

From wholesaler to
manufacturer, first moulds
are purchased



01.2010
Eberstallzell:
Moving into the new building,
new company name
PET Handels GmbH &
new brand identity

07.2011



05.2017
Eberstallzell:
Photovoltaic system
is installed

01.2021
New company name
PET Austria GmbH

04.2022
INNOXAT as a trade
mark registered
INNOXAT

10.2022
Our
battery smoothing machine
is fully developed and
patent has been registered



08.2000
Wels:
First relocation &
Enlargement of
warehouse and office



04.2002
Graz:
Takeover of company Ki-
wisch. PET thus enters the
production of
smoothing machines &
compulsory mixers



Locations Graz
and Villach
were closed

04.2006

06.2008
EPF Feuchtwagen (D):
Trade fair exhibitor abroad
for the first time



09.2009
Eberstallzell:
Construction of our new
company building begins



07.2016
Purchase of the first electric cars



02.2016
Eberstallzell:
Start of production for the
ULTRALIGHT mortar hose



Official company takeover
from Daniel Ziegelbäck

01.2020



05.2023
Eberstallzell:
Shop is rebuilt into
new office space



08.2018
Eberstallzell:
Company building is
extended by a second
warehouse



01.2025
25 years PET

Our Team



Daniel



Sonja



Dado



Martin



Margit



Steffen



Andrea



Natascha



Herbert



Maksym



Ivan



Michelle



Leonardo



Dieter



Omar



Svetlana



Marijana



Daniel



Ines



Mireille



Olaf

Our name PET stands for Production of Equipment & Tools.
Of course Austria stands for our home country.

We are an owner-managed company from Upper Austria.
We already deliver our products to over 40 countries on 3 continents.



Our mission is to make work on construction sites
around the world easier with innovative products.

That's why we want to be the independent partner for machine manufacturers,
specialised dealers, and the mortar industry in the area of plaster, screed, drywall and
concrete, in order to reach as many people as possible with our innovations.

In this way, we want to be successful in the long term and create jobs that are worth living
for our employees and support social and sustainable projects.

Our strengths.

Quality standards.

We place very high value on the quality of our products. Not only the in-house production, but also outsourced productions are regularly controlled. Due to long term partnerships with our pre-suppliers and quite a few molds produced especially for us, we are not only able to maintain our quality standard, but also constantly improve it.

Know-how.

More than 40 years of experience in the industry and the know-how of our employees stand for our competence. Also our exchange directly with the users on the construction site.

Development.

In addition to the development of new products we are also focusing on the further development of existing products. We are fully geared to the demand and testing of professionals in the construction site. Direct exchange with the users on the construction site is also very important to us and is part of our product development.



EXPERTISE FOR
OVER 40 YEARS



SPECIAL RANGE IN PLASTER,
SCREED, DRY CONSTRUCTION
AND CONCRETE



95% OF CATALOGUE
ITEMS ARE IN STOCK



FAIR PRICES FROM
THE FIRST PIECE



EXPERT FOR
SPECIAL SOLUTIONS



OWN TRANSPORT FLEET
AND KNOW-HOW IN
LOGISTICS

With the flexibility of a manufacturer,
we will also find individual solutions for your needs.

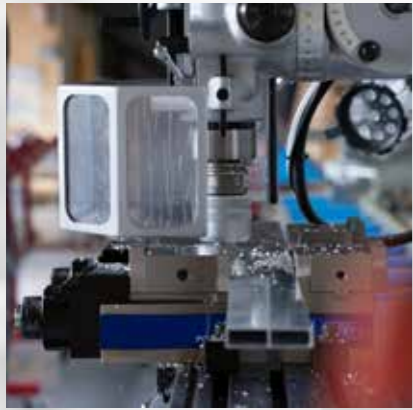

Our brand:

INNOXAT

„INNO“ stands for innovation

Because it is our greatest pleasure to develop innovations,
which are perfectly adapted to the needs of the construction site.

our red „X“ - for brand identification

Has stood for the quality of our products for many years,
as well as for the X-tra Power that we give every day.

„AT“ stands for AUSTRIA

Our home country and the quality from here.

In addition, more and more products come from our own production „Made in Austria“

Use our sales shelves to boost your sales!

We have created sales shelves for you with all the important products
that the user needs on the construction site.

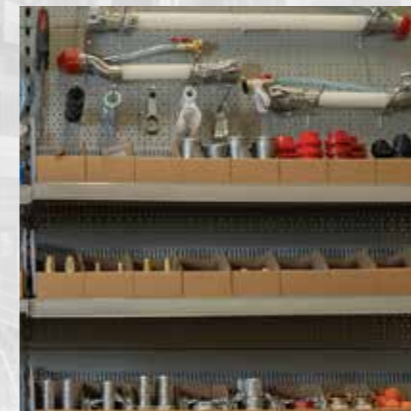

Your advantages:

- You get the sales shelf for FREE.
- Your employees will receive detailed product training from us.
- Your retail prices are calculated that you earn a good profit on sales.
- We are happy to provide you with list prices for professional customers.

A		Dosing needle for foam gun	154
Absorption barrier	172	Driller for concrete wire	155
Adapter for discharge stand	93, 95	Dripnose profiles	168
Air compressor and spare parts	30	Driving dog	31
Air fitting for spraying gun	19	Drywall profiles	173-175
Air hoses for screed machines	60	Drywall tools	149
Air hoses for spraying gun	18		
Air nozzle pipe	16	E	
Air valve	17, 61	Edge insulation strip cutter	112
Aluminium corner bead drywall	173	Electrical accessories	42-43
Aluminium sponge float+handles	134, 143	Electrical distributors	43
Anchor discs ETICS	165	Emulsifier	45
Angle L-shaped	176	ETICS profiles	167-169
		EWO couplings	18
B		Expansion joint beads	169-176
Backpack vacuum cleaner	138	Extension rung for wooden ladder	123
Bags and belt	156		
Ball valves plastering machine	17	F	
Ball valves screed machine	61	Fiberglass mesh	164
Battery power scissors	151	Filling hopper screed pump	57
Battery power trowels	106-107	Filling level indicator	45
Battery reciprocating saw	161	Filter bags	41
Battery screed smoothing machine	102-103	Filter element for compressor	40
Bearings for screed machine	63-65	Filter strap	41
Bevelling shears and blades	151	Fine adjustment valve	36
Brick trowel	131	Fitting holder for spraying gun	16
Bricklayer cord	155	Flange plate for discharge stand	83, 95
Brushes	145	Floor scraper	152
Buckets	153	Floor spatula	114
		Flow meter	34-35
C		Foam guns	154-155
Cables and plugs	42-43	Free Flow delivery hoses	74
Cardan couplings KK70	88-89		
Cardan couplings KK89	90	G	
Cealing tape	181	Garbage bags	181
Chalk liner	155	Geka couplings	99
Check valve	60	Glass fibers	176
Citrus cleaner	169	Gloves	121
Claw couplings	98-99	Glue	144
Cleaning coupling	86	Glue guns	29
Cleaning shafts and mixer cleaner	33	Grinding mesh	149
Clipping on drywall profiles	174	Grinding ring	104
Coating roller and accessories	145	Grouting float	143
Compound pliers	149	Gun cleaner for foam gun	155
Compressed tapes	181		
Concrete binder (chemistry)	172	H, I, J	
Concrete binding wire	155	Hammer tacker and staples	152
Concrete trowel	115	Hammers	156
Cone shut off valve	17	Hand grinder	149
Connecting beads ETICS	167-169	Handle for mortar coupling	87
Construction chemistry	172	Handles	133-134, 145
Construction foils	177	Hinge pin for tiling flange	32
Conveyor system spare parts	45	Hopper screed pump	57
Corner bead profiles aluminium	173	Hose clamps	87, 97
Corner bead profiles galvanised	171	Hose holder	91
Corner trowels	131	Hose nozzles	86
Coupling cramps	31	Hose protection spiral	91
Couplings compressor	60	h-profiles and T-profiles	126
Couplings system „Perrot“	88-90	Insulation cutter	161
Cover hood plastering machine	41	Insulation knife	150
Cover sealing screed machine	62	Insulations anchors ETICS	165
Cuff for shut-off damper	45	Jet nozzles	15
		Joint discs	49
D			
Damp proof foils	177	K	
De-airing wobble bars	116-118	Knee pads	120
Delivery hoses	74	Knives and saws	150
Depth gauge bead	171		
Discharge stands and accessories	82-95		

L		M	
Ladders and accessories	122-124	Magnetic valve	36
LED lamps	157	Manometer	38-39
Levels	108-111	Masking fleece	180
		Masking paper	180
		Masking tapes	177-179
		Masking tapes with foil	178
		Measuring tapes	156
		Membrane for air compressor	30
		Membrane window beads	166-167
		Metal shears	151
		Mixer and stirring rods	153
		Mixer cleaner, cleaning shafts	33
		Mixer shafts screed machine	62
		Mixing blades and holder	50-54
		Mixing bracket	52
		Mixing spiral	32
		Mixing tools screed pump	50-54
		Mixing vessel outlets	58-59
		Mortar couplings and accessories	82-87
		Mortar hose clamps	87
		Mortar hoses	69-81
		Mortar nozzles flexible	15
		Mortar pressure manometer	39
		Mortar trough	153
		Mounting roller window beads	169
		N,O	
		Nailed shoes	114
		Needle valve	36
		Nozzle cleaner	17, 149
		P,Q	
		Paint grid	145
		Painter's felt	180
		Pallet cover hood	181
		Perforated plates	45
		Plaster finishing machine	139-141
		Plaster flat blade	130
		Plaster guns	29
		Plaster nozzles	15
		Plaster pan	130
		Plaster planes	146-147
		Plaster profiles external	170-171
		Plaster profiles internal	171
		Plaster scraper	130
		Plaster spraying guns	20-28
		Plaster stop bead	171
		Plasterboard transporter	149
		Pointing trowel	130
		Pouring hoses	69-70, 79
		Power grinder and plaster finisher	136-141
		Power trowels	106-107
		Powerband	65
		Pressing sleeves hydraulic	86
		Pressure flanges and tension rod	40
		Pressure reducer	37
		Pressure switch	41
		Primer	172
		Proble cable and plugs	43
		PVC corner drywall	173-175
		PVC corner with mesh	168

R		S	
Rainwater gutter tube	181	Saws	150
Reciprocating saw	161	Scaffold foils	177
Remote control cables	44	Scraper wire rope	65
Reveal beads and accessories	166-169	Screed anchors	176
Rotors	46-49	Screed clamp	176
Rubber pot for discharge stand	93	Screed expansion joint	176
		Screed expansion joint trowel	115
		Screed gauge	113
		Screed glass fibers	176
		Screed laying pants	119
		Screed levelling tripod	115
		Screed measuring instrument	176
		Screed smoothing machine	102-103
		Screed smoothing shoes	120
		Screeding level	108-111
		Screeding trowels	115
		Screw fitting for flow meter	35
		Screw handle spatulas	135
		Screw-in nozzle	86
		Sealing cone screed machine	60
		Sealings for conveyor system	45
		Sealings for plastering machine	41
		Shadow joint profiles	175
		Sheet steel connecting bead	169
		Silicone spray	47
		Silo vibrator	45
		Skimmer float	148-149
		Smoothing discs	104-105
		Smoothing shoes screed	120
		Smoothing spatulas ALU	132-134
		Smoothing trowels	128-129
		Socle profile PVC	168
		Socle stop bead	171
		Solenoid valves	36
		Spatulas and accessories	130-135
		Spike roller	114
		Spirit levels	111
		Sponge floats and accessories	142-144
		Sponge pads for floats	144
		Sponge rubber balls	91
		Spraying caps	15
		Spraying head sets	18
		Spraying heads	14
		Spritzjet TWIST	26-27
		Staples	152
		Stators	46-49
		Stone trap screed machine	89
		Stop bead drywall	175
		Stopcock	36
		Storz couplings	75
		Strainer filter for geka coupling	36
		Styrofoam cutters and accessories	158-160
		Swivel castor	40
		Swivel joint	16

T,U		V	
Tacker and staples	152	Vacuum cleaner	138
Tension rods for pressure flange	40	Valve plates for air compressor	30
Threaded pipes	16	Vessel outlets	58-59
T-key for rotors	47	Vibrating motor for silo	45
TRIPLEX 360° floodlight	157		
Trowels toothing	127	W,X,Y	
Ultralight mortar hoses	69-73	Wall plane	149
		Wall scrapers	134-135
		Wall vapour protection	181
		Water and air hoses	96-97
		Water couplings and accessories	98-99
		Water flow meter	34-35
		Water spray nozzle	98
		Waved connector for cracks	176
		Wear plates	54-56
		Well wheel and rope	155
		Window beads and accessories	166-169
		Wire angle	170
		Wooden ladders and accessories	122-124
		Wooden trestles	125
		Z	
		Zargo glue guns	29

from page 12

from page 66

from page 100

from page 162



Spray head TWIST 35
Page 14



Threaded pipe ALU
Page 16



Spritzjet TWIST 35
Page 27



Mixing pipe
Page 32



Manometer
Page 38



Mortar pressure gauge
Page 39



T-key
Page 47

Spare parts and wear parts 12-65

Parts for plastering machines

Plaster spraying guns – single parts	14
Plaster spraying guns – complete	20
Glue guns and plaster guns	29
Spare parts for air compressor	30
Coupling cramps	31
Mixing spirals and mixing pipe	32
Mixing cleaner and cleaning shafts	33
Spare parts for water fitting	34
Manometer	38
Spare parts for plastering machines	40
Electrical cables and distributors	42
Probe cables and spare parts	44
Spare parts conveyor system	45
Stators and rotors	46

Parts for screed pumps

Mixing blades	50
Wear plates	54
Filling hopper	57
Mixing vessel outlets	58
Air hoses and check valve	60
Ball valves screed pump	61
Mixer shafts and cover sealing	62
Bearings	63
Compressor coupling, powerband, scraper rope	65

NOTE:
All spare parts are of high quality, but as a rule they are not original spare parts.

All products labelled with **X** are from our own production or are produced exclusively for us according to our specifications..

Spraying heads



Plaster nozzles and screws

Spray head TWIST steel 45° angled
1" IG, 25 mm,
with air nozzle pipe, for Spritzjet

Item 4055-000



Spray head TWIST steel straight
1" IG, 25 mm,
with air nozzle pipe, for Spritzjet

Item 4055-002



Spray head plastic 30° angled
1" IG, 25 mm, made of PP
for screws with M8 thread

Item 4053-001



Spray head ALU 45° angled
1" IG, 25 mm,
for screws with M10 thread

Item 4050-000



Spray head ALU 30° angled
1" IG, 25 mm,
for screws with M10 thread

Item 4050-001



Spray head ALU straight
1" IG, 25 mm,
for screws with M10 thread

Item 4050-002



Spray head ALU 35 mm straight, with integrated steel coupling VT35,
for screws with M10 thread

Item 4058-135



Spray head TWIST 35 steel straight IG
1 1/4" IG,
with air nozzle pipe, for Spritzjet

Item 4055-005



Spray head TWIST 35 steel straight AG
1 1/4" AG,
with air nozzle pipe, for Spritzjet

Item 4055-006



Jet nozzle TWIST

conical type, with thread, for Spritzjet

Item	hole
4055-008	8 mm
4055-010	10 mm
4055-012	12 mm
4055-014	14 mm
4055-016	16 mm
4055-020	without hole



Plaster nozzle SK

conical type, made of rubber,
low-vibration type with reinforced flap

Item	dimension
4050-052	12 mm
4050-054	14 mm
4050-056	16 mm



Plaster nozzle FK

conical type,
made of Polyurethan,
highly wear-resistant

Item	hole
4050-108	8 mm
4050-110	10 mm
4050-112	12 mm
4050-114	14 mm
4050-116	16 mm



Flexible mortar nozzle KD

straight type,
wear-resistant,
with fastening clip

Item	hole
4058-018	18 mm
4058-019	20 mm



Eyebolt

M10x20 mm,
with small ring

Item 4050-007



Wing screw

M8x20 mm

Item 4502-402



Single parts for Plaster spraying guns



Mount fitting FIX
for Plaster spraying guns
version FIX with POM 400 mm,
thickness 1,8 mm

Item 4050-004



Mount fitting slidable
for air valve 3/8",
only usable with PVC pipe

Item 4050-009



Mount fitting Nylon
3/8" IG universal,
metal part overmolded

Item 4050-005



Threaded pipe POM 1" AG
24x37 mm, white, PN40

Item	length
4050-150	100 mm
4050-151	200 mm
4050-152	400 mm
4050-153	600 mm
4050-154	800 mm
4050-155	1000 mm
4050-157	1500 mm



Threaded pipe PVC 1" AG
26x34 mm, white, PN30

Item	length
4050-161	200 mm
4050-164	250 mm
4050-162	400 mm
4050-165	500 mm
4050-163	600 mm
4050-166	750 mm
4050-167	1000 mm
4050-168	1250 mm
4050-169	1500 mm



Threaded pipe ALU 1" AG
26x32 mm, PN40

Item	length
4050-091	150 mm
4050-092	230 mm
4050-093	400 mm
4050-094	600 mm
4050-095	717 mm
4050-096	800 mm
4050-097	1000 mm



Swivel joint ALU DN 25
1" IG/AG universal
length 100 mm

Item 4050-160



Air nozzle pipe 10 mm

Item	length	hole
4050-143	140 mm	6 mm
4050-148	180 mm	6 mm
4050-144	140 mm	4 mm for RITMO



Air nozzle pipe 10 mm
with 1/4" AG,
length 145 mm, hole 6 mm

Item 4050-145



Ball valve 3/8" AG
9 mm nozzle,
double winged
full passage,
application -20° to 150°

Item 4050-127



Ball valve with handle made of steel
1/4" IG/IG, PN64
full passage,
application -20° to 150°

Item 4050-120



Ball valve double winged
1/4" IG/IG, PN64
full passage,
application -20° to 150°

Item 4050-121



Ball valve hexagon one-wing
1/4" IG/IG, PN10
full passage,
application -20° to 150°

Item 4050-122



Ball valve 3/8" with hole 2,4 mm
full passage,
application -20° to 150°
double winged,
with nozzle 9 mm

Item 4050-129



Ball valve with handle made of steel
3/8" IG/AG, PN64
full passage,
application -20° to 150°

Item 4050-123



Ball valve double winged
3/8" IG/AG, PN64
full passage,
application -20° to 150°

Item 4050-124



Ball valve hexagone one-wing
3/8" IG/AG, PN10
full passage,
application -20° to 150°

Item 4050-125



Ball valve double winged
1/2" IG/AG, PN25
full passage,
application -20° to 150°

Item. 4100-049



Plug valve Aluminium 1"
weight 0,51 kg,
with steel handle,
easily dismountable for
cleaning, adjustable

Item 4290-033



Plug valve brass 1"
weight 0,92 kg,
with steel handle,
easily dismountable for
cleaning, adjustable

Item 4290-034



Nozzle cleaner
for Plaster spraying guns
5,0 mm, with 2K-handle,
drilling length 170 mm

12 pcs in a box

Item 4090-190



Spare parts and wear parts

Spare parts and wear parts

Spare parts and wear parts

Spare parts and wear parts

SET spray head ALU 45°
1" IG, 25 mm
with air nozzle pipe,
plaster nozzle FK 12mm and
fixing screw M10x20 mm

Item 4050-022



SET spray head ALU 30°
1" IG, 25 mm
with air nozzle pipe,
plaster nozzle FK 12 mm and
fixing screw M10x20 mm

Item 4050-032



SET spray head ALU straight
1" IG, 25 mm
with air nozzle pipe,
plaster nozzle FK 12 mm and
fixing screw M10x20 mm

Item 4050-042



Air fitting FIX
with claw coupling + 1/4" ball valve
with air nozzle pipe 4050-145

Item	for
4050-170	S 200
4050-171	M 400
4050-172	L 600
4050-173	XL 800



Air fitting
with claw coupling,
holder Nylon + 3/8" ball valve
with air nozzle pipe 4050-143

Item	for
4050-180	S 200
4050-181	M 400
4050-182	L 600
4050-183	XL 800
4050-184	XXL 1000



Air fitting FIX
with blow out unit
+ 2 ball valves 1/4" and 3/8"
3/8" ball valve with hole,
with holder Nylon
and air nozzle pipe 4050-145,
for 35 ALU DUO

Item 4058-198



Air fitting
with blow out unit
+ 2 ball valves 3/8"
1 ball valve with hole,
with holder Nylon
and air nozzle pipe 4050-143,
for 35 ALU DUO

Item 4058-199



Hose screw connection AG
with nozzle 10 mm

Item	dimension	nozzle
4050-140	1/4"	10 mm
4050-141	3/8"	10 mm
4050-142	1/2"	13 mm



EWO coupling VT
Plug nipple 3/8" AG
wrench size 17

Item 4050-119



Air hose 10 mm,
transparent with fabric
for air fitting

Item	length	for
4050-131	200 mm	S 200
4050-132	250 mm	S 200
4050-133	380 mm	M 400
4050-134	450 mm	M 400
4050-135	580 mm	L 600
4050-136	650 mm	L 600
4050-137	780 mm	XL 800
4050-138	850 mm	XL 800



Air fitting without air hose
with claw coupling,
holder Nylon + 3/8" ball valve

Item 4050-197



Air fitting
with claw coupling,
holder FIX + 3/8" ball valve
for Spritzjet TWIST FIX

Item	for
4055-170	S 200
4055-171	M 400
4055-172	L 600



Air fitting
with claw coupling,
holder Nylon + 3/8" ball valve
for Spritzjet TWIST FIX

Item	for
4055-180	S 200
4055-181	M 400
4055-182	L 600



Plaster spraying guns S 200 mm



Plaster spraying guns M 400 mm

Plaster spraying gun S 200 mm

with spray head 25 1" IG ALU straight, plaster nozzle FK12, fixing screw M10x20 mm and air fitting with claw coupling, holder Nylon white + 3/8" ball valve



Plaster spraying gun M 400 mm

with spray head 25 1" IG ALU 30°, plaster nozzle FK12, fixing screw M10x20 mm and air fitting with claw coupling, holder Nylon white + 3/8" ball valve



without coupling 1" AG

Item	threaded pipe
4050-2000	POM
4050-2400	PVC



with ALU swivel joint 1" AG

Item	threaded pipe
4050-2001	POM
4050-2401	PVC



with ALU MT25 360° coupling

Item	threaded pipe
4050-2002	POM
4050-2402	PVC



without coupling 1" AG

Item	threaded pipe
4052-3000	POM
4052-3400	PVC



with ALU swivel joint 1" AG

Item	threaded pipe
4052-3001	POM
4052-3401	PVC



with ALU MT25 360° coupling

Item	threaded pipe
4052-3002	POM
4052-3402	PVC



with ALU MT25 coupling

Item	threaded pipe
4050-2003	POM
4050-2403	PVC



with PVC MT25 coupling

Item	threaded pipe
4050-2004	POM
4050-2404	PVC



with steel MT25 coupling

Item	threaded pipe
4050-2005	POM
4050-2405	PVC



with ALU MT25 coupling

Item	threaded pipe
4052-3003	POM
4052-3403	PVC



with PVC MT25 coupling

Item	threaded pipe
4052-3004	POM
4052-3404	PVC



with steel MT25 coupling

Item	threaded pipe
4052-3005	POM
4052-3405	PVC



with claw coupling brass

Item	threaded pipe
4050-2007	POM
4050-2407	PVC



with claw coupling 360°

Item	threaded pipe
4050-2008	POM
4050-2408	PVC



with claw coupling brass

Item	threaded pipe
4052-3007	POM
4052-3407	PVC



with claw coupling 360°

Item	threaded pipe
4052-3008	POM
4052-3408	PVC



NOTE: All plaster spraying guns can also be manufactured with an ALU threaded pipe on request.

NOTE: All plaster spraying guns can also be manufactured with an ALU threaded pipe on request.

Spare parts and wear parts

Spare parts and wear parts

Plaster spraying guns L 600 mm

Plaster spraying gun L 600 mm

with spray head 25 1" IG ALU 30°, plaster nozzle FK12, fixing screw M10x20 mm and air fitting with claw coupling, holder Nylon white + 3/8" ball valve



without coupling 1" AG

Item	threaded pipe
4052-4000	POM
4052-4400	PVC



with ALU MT25 coupling

Item	threaded pipe
4052-4003	POM
4052-4403	PVC



with claw coupling brass

Item	threaded pipe
4052-4007	POM
4052-4407	PVC



with ALU swivel joint 1" AG

Item	threaded pipe
4052-4001	POM
4052-4401	PVC



with PVC MT25 coupling

Item	threaded pipe
4052-4004	POM
4052-4404	PVC



with claw coupling 360°

Item	threaded pipe
4052-4008	POM
4052-4408	PVC



with ALU MT25 360° coupling

Item	threaded pipe
4052-4002	POM
4052-4402	PVC



with steel MT25 coupling

Item	threaded pipe
4052-4005	POM
4052-4405	PVC



Plaster spraying guns XL 800 mm

Plaster spraying gun XL 800 mm

with spray head 25 1" IG ALU 30°, plaster nozzle FK12, fixing screw M10x20 mm and air fitting with claw coupling, holder Nylon white + 3/8" ball valve

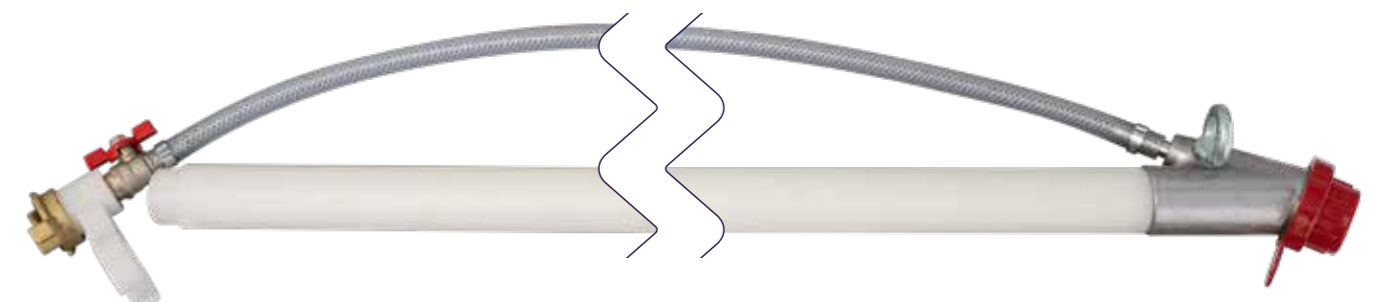

with ALU MT25 360° coupling

Item	threaded pipe
4052-5002	POM
4052-5402	PVC



with PVC MT25 coupling

Item	threaded pipe
4052-5004	POM
4052-5404	PVC



with steel MT25 coupling

Item	threaded pipe
4052-5005	POM
4052-5405	PVC



NOTE:

All plaster spraying guns are manufactured in our production facility in Eberstzell. We are therefore very happy to respond to individual customer requests. We can also produce all our plaster spraying guns units in the lengths 1000 mm, 1250 mm and 1500 mm.

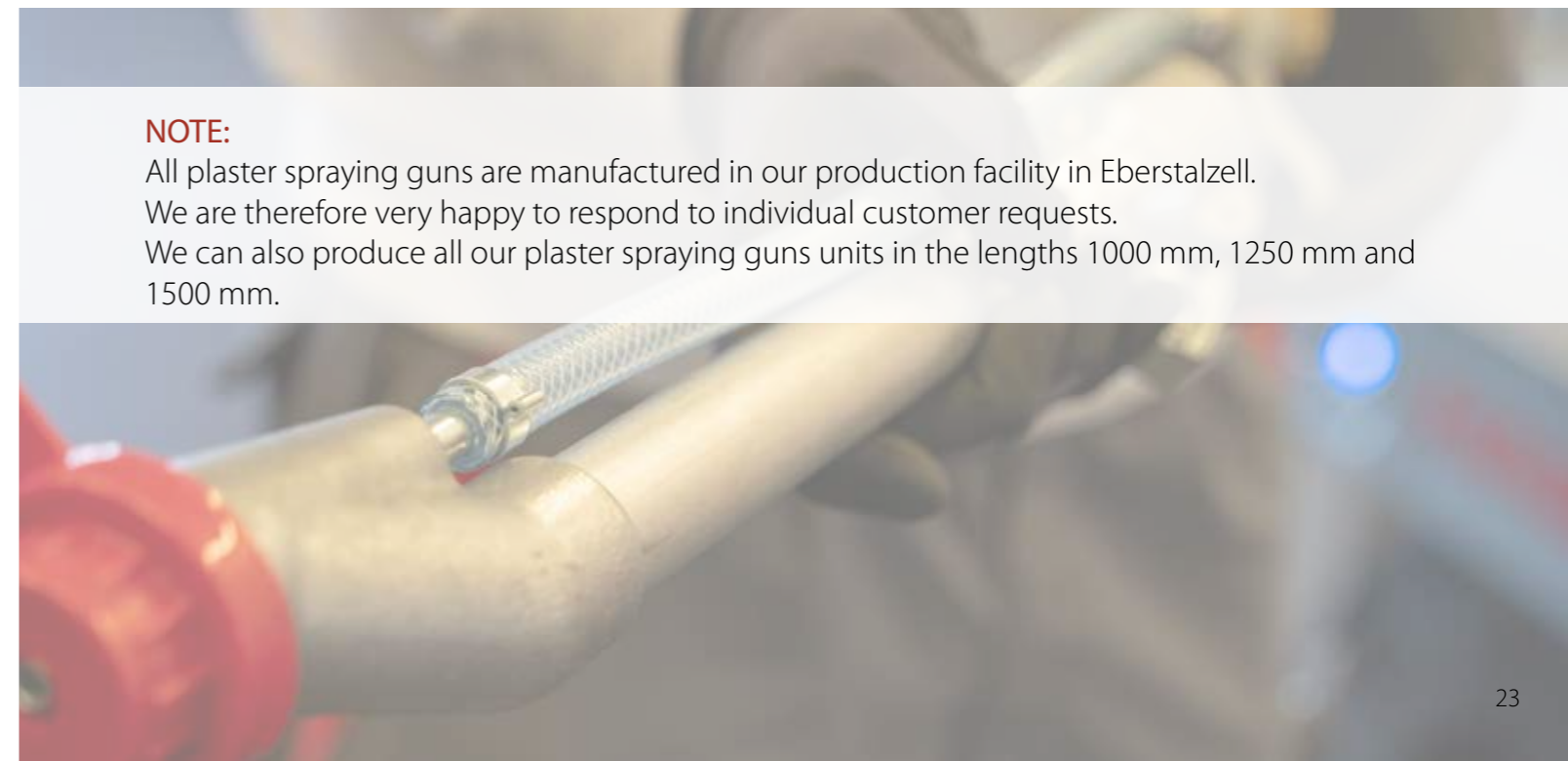

Plaster spraying guns FIX and RITMO

INNOXAT

Plaster spraying gun S 200 mm FIX

with POM threaded pipe, spray head 25 1" IG ALU straight, plaster nozzle FK12, fixing screw M10x20 mm, air fitting FIX with claw coupling + 1/4" ball valve and air nozzle pipe



without coupling 1" AG

Item 4050-2010



with PVC MT25 coupling

Item 4050-2014



with PVC MT25 coupling + holder Nylon

Item 4050-2024



Plaster spraying gun S 200 mm RITMO

with POM threaded pipe, spray head 25 1" IG ALU straight, plaster nozzle FK10, fixing screw M10x20 mm, air fitting with EWO coupling, holder Nylon and air nozzle pipe 4 mm and ALU MT25 360° coupling

Item 4050-2052



Plaster spraying guns FIX and with plug valve

Plaster spraying gun FIX

with POM threaded pipe, spray head 25 1" IG 30°, plaster nozzle FK12, fixing screw M10x20 mm, air fitting FIX with claw coupling, holder FIX + 3/8" Ball valve and PVC coupling MT25
The fixed air cock reacts promptly and precisely.

Item	length
4052-3034	M 400 mm
4052-4034	L 600 mm



Plaster spraying gun with plug valve

with POM threaded pipe, spray head 25 1" IG straight, plaster nozzle FK12, fixing screw M10x20 mm, air fitting with claw coupling, holder Nylon white + 3/8" ball valve and ALU MT25 coupling



with plug valve aluminium and steel handle
length 300 mm

Item 4050-2102



with ball valve PN40 and steel handle
length 300 mm

Item 4052-2203



Spritzjet TWIST FIX 25



Spritzjet TWIST 35

Spritzjet TWIST FIX 25

with ALU MT25 360° coupling, spraying nozzle TWIST 12 mm and air nozzle pipe.
The fixed ball valve reacts promptly and accurately.
For all plastering machines up to a graining of 4mm.
The spray head made of steel fits perfectly in your hand, no matter in which position.
Stepless transition to the threaded pipe (POM).
Due to the rotatable aluminium coupling, the hose remains stable on the floor.

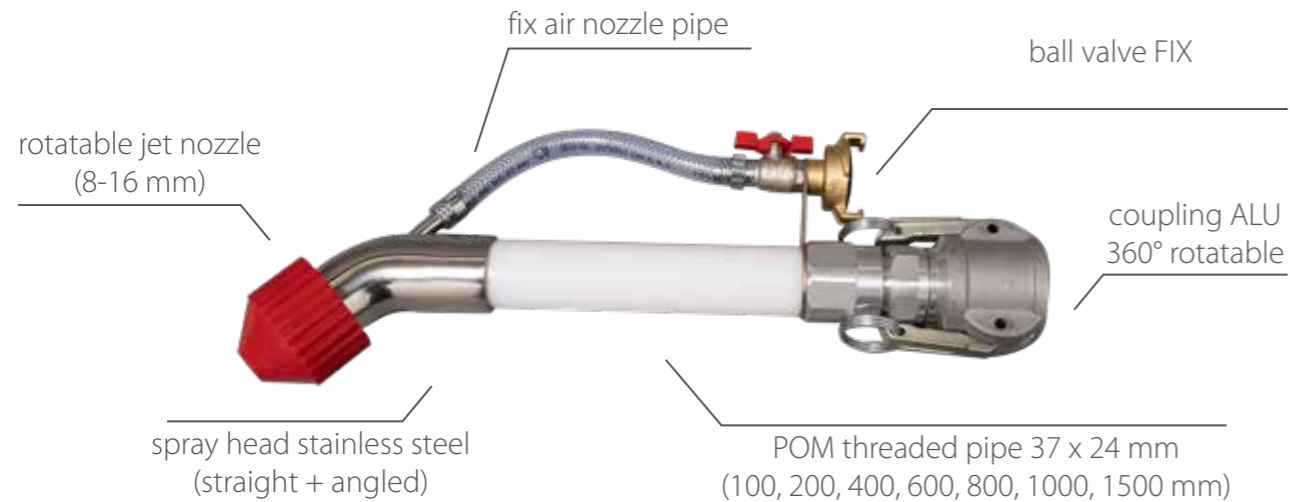

with spray head stainless steel straight

Item	length
4055-2032	S 200 mm
4055-3032	M 400 mm
4055-4032	L 600 mm



with spray head stainless steel straight with plug valve

length L 600 mm

Item 4055-4132

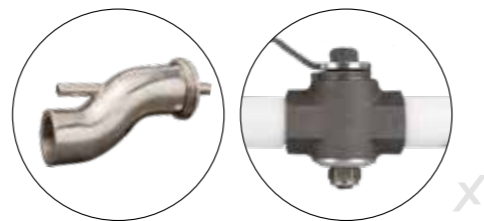

with spray head stainless steel angled 45°

Item	length
4057-2032	S 200 mm
4057-3032	M 400 mm
4057-4032	L 600 mm



with spray head stainless steel angled 45° with plug valve

length L 600 mm

Item 4057-4132



Spritzjet TWIST 35

spray head TWIST 35 1 1/4" IG stainless steel straight, spraying nozzle TWIST 12 mm, ball valve FIX with claw coupling + 1/4" ball valve, with steel MT35 coupling

Item 4055-0914

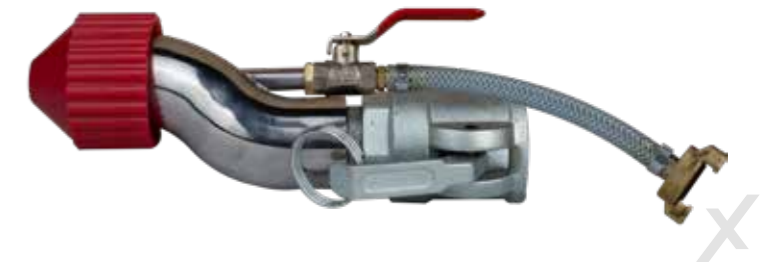

Spritzjet TWIST 35

spray head TWIST 35 1 1/4" IG stainless steel straight, spraying nozzle TWIST 12 mm, ball valve FIX with claw coupling + 1/4" ball valve, with steel MT35 360° coupling

Item 4055-0915



Spritzjet TWIST 35

spray head TWIST 35 1 1/4" IG stainless steel straight, spraying nozzle TWIST 12 mm, ball valve FIX with claw coupling + 1/4" ball valve, with steel VT35 coupling

Item 4055-0918



Spritzjet TWIST 35

spray head TWIST 35 1 1/4" IG stainless steel straight, spraying nozzle TWIST 12 mm, ball valve FIX with claw coupling + 1/4" ball valve, with steel VT35 360° coupling

Item 4055-0919



Plaster spraying guns type 35

INNOXAT

Plaster spraying gun type 35 ALU

with spray head VT35, plaster nozzle KD18 and fixing screw M10x20 mm, and holder Nylon, length 185 mm



MONO type 35

with air fitting, claw coupling and 3/8" ball valve

Item 4058-00098

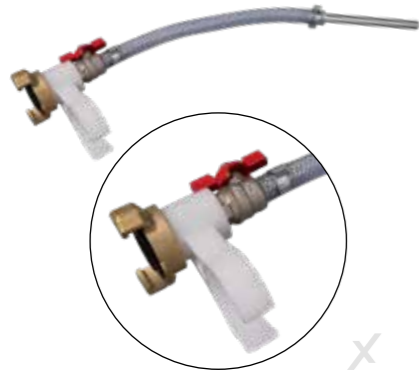

MONO FIX type 35

with air fitting FIX, claw coupling and 1/4" ball valve

Item 4058-00198

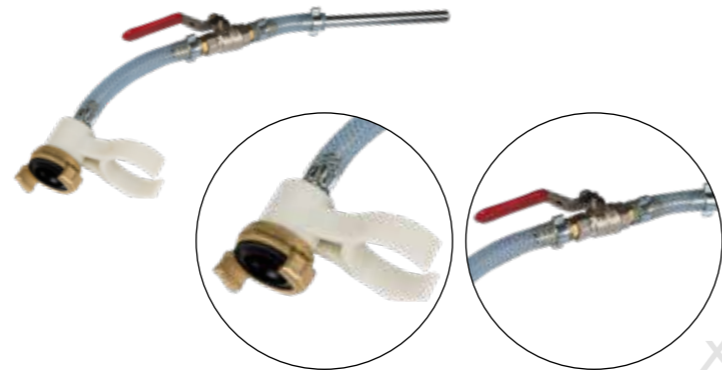

DUO type 35

with air fitting with blow out unit, claw coupling and two ball valves

Item 4058-00798

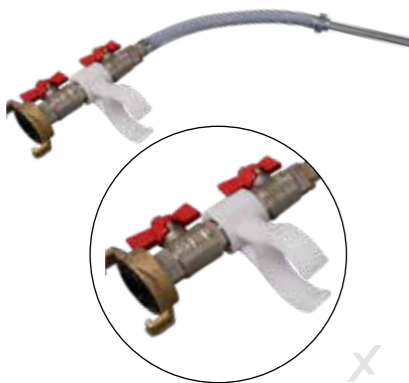

DUO FIX type 35

with air fitting FIX with blow out unit, claw coupling and two 1/4" ball valves

Item 4058-00898

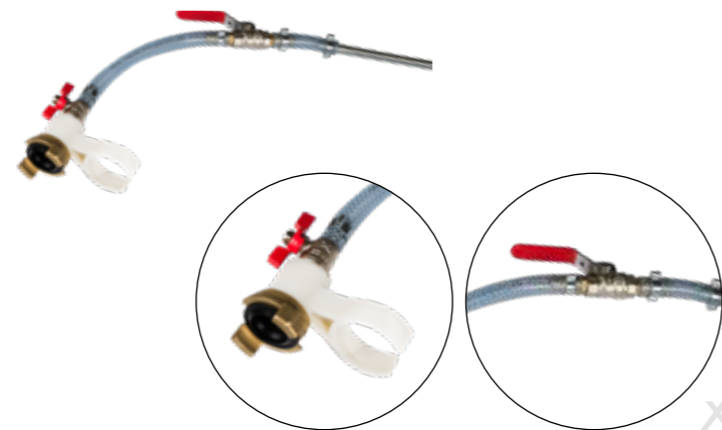

Glue guns and plaster guns

Zargo

The built-in ball valve prevents the material from swelling of the mortar gun after switching off the machine.

Guarantees clean working without material loss.

The ZARGO consists of a mortar coupling, a brass coupling with hose part and a handle with electric ON/OFF-switch as well as a remote control cable (75cm).

Zargo ECO

with steel MT25 coupling and ball valve weight 2,38 kg

Item 4060-200



Zargo PRO

with ALU MT25 360° coupling and plug valve ALU weight 2,03 kg

Item 4060-210



Zargo PRO UL

with ALU MT25 coupling and plug valve ALU rotating joint and 1,5 m Ultralight hose DN25 weight inclusive hose 2,52 kg

Item 4060-215



Plastering gun with 6 liter funnel

9-hole nozzle disc 4-13 mm, air requirements approx. 220 l/min

Item 5800-000

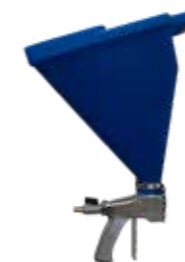

Plastering gun with 5,5 liter funnel

nozzles 4,6,8 mm, air requirements approx. 200-300 l/min, pressure 4,5-6 bar

Item 5800-001



Spare parts for air compressor



Coupling cramps

Spare parts and wear parts

Spare parts and wear parts

Filter element
100 mm

Membrane

Valve plate piston

Coupling clamp

Fine casting with funnel for 25 mm shaft
universal - G4, Ritmo, Bionik compatible



Item 4100-510

Item 4100-511

Item 4100-512

Item 4100-005



Valve plate cylinder-head
no stroke liwither necessary

Safety valve 1/4"
3,5 bar, with sealing

EWO coupling
female part 1/4" AG

Coupling clamp steel
for 25 mm shaft,
with funnel,
for G4, VR6, M5, Ritmo

Coupling clamp steel
for 30 mm shaft,
with funnel,
for G4, VR6, M5

Item 4100-513

Item 4100-514

Item 4100-515

Item 4100-004

Item 4100-006



EWO coupling
male part 1/2" nozzle

Coupling clamp steel
for MP25, MSX, Mixer
for 25 mm shaft,
with funnel

Coupling clamp
for S48, VR8, M and m-tec

Item 4100-516

Item 4120-003

Item for

4110-003 25 mm shaft

4110-004 30 mm shaft



Mixing spirals and mixing pipe

Mixer cleaner and cleaning shafts

Mixing pipe with D-pump flange
for G4, VR6, M5,
without engine mount



Item 4100-131

Hinge pin
Motor tilting flange galvanised
for G4, VR6, M5

Item 4100-132



Mixer cleaner
for Ritmo L/M,
length 210 mm

Item 4100-121



Cleaning shaft
for Ritmo L/M.
length 695 mm

Item 4100-122



Mixing spiral
armoured,
for G4, VR6, M5,
length 520 mm

Item 4100-100



Mixing spiral for light plaster
armoured,
for G4, VR6, M5,
length 520 mm

Item 4100-101



Mixing spiral
for insulation plaster
armoured,
for G4, VR6, M5,
length 520 mm

Item 4100-102



Mixer cleaner
for G4, VR6, M5,
length 250 mm

Item 4100-001



Cleaning shaft
for G4, VR6, M5,
length 520 mm

Item 4100-002



Mixing spiral
for MP25,
length 460 mm

Item 4120-100



Mixing spiral
for MSX, G78, P36,
length 545 mm

Item 4120-101



Mixing spiral
for S48, VR8, M1,
length 550 mm

Item 4110-100



Mixer cleaner
for S48, VR8, M1,
length 201 mm

Item 4110-001



Cleaning shaft
for S48, VR8, M1,
length 460 mm

Item 4110-002



Mixing spiral
for M3,
length 565 mm

Item 4130-100



Mixing spiral
for Ritmo L/M,
length 695 mm

Item 4100-120



Mixer cleaner
for MP25,
length 245 mm

Item 4120-001



Cleaning shaft
for MP25.
length 550 mm

Item 4120-002



Water flow meters



Water flow meter type 1000/1500

complete with screw fittings 1/2" IG, length 350 mm, for G4, VR6, M5

Item	type	flow rate
------	------	-----------

4100-300	1000	100-1000 l/h
4100-301	1500	150-1500 l/h



Water flow meter type 1000/1500XL

complete with screw fittings, 1 1/4" AG, length 380 mm

Item	type	flow rate
------	------	-----------

4100-298	1000XL	100-1000 l/h
4110-299	1500XL	100-1500 l/h



Water flow meter type 1600

flow rate 160-1600 l/h, complete with screw fittings 1 1/4" AG, length 350 mm, for S48, VR8, M1

Item 4110-300



Water flow meter type 1600TG

flow rate 160-1600 l/h, complete with screw fittings 3/4" IG + TG, length 390 mm, for S48, VR8, M1

Item 4110-301



Water flow meter type 1000XS

Flow rate 100-1000 l/h, complete with screw fittings 1/2" IG, length 280 mm, for Mischer

Item 4100-295



Water flow meter type 2500

flow rate 250-2500 l/h, complete with screw fittings 3/4" IG, length 380 mm, for Mischer, SMP

Item 4100-305



Spare parts for water flow meters

Plastic threaded pipe without screw fittings

Item	for	flow rate
------	-----	-----------

4100-310	type 1000	100-1000 l/h
4100-311	type 1500	150-1500 l/h



Plastic threaded pipe without screw fittings for type 1600

Item 4110-310



Screw fitting 1/2" IG, for type 1000 and 1500

Item 4100-320



Screw fitting long version, 1 1/4" AG, for type 1000 and 1500

Item 4100-321



Screw fitting short version, 1 1/4" AG, for type 1600

Item 4110-320



Connector TG with union nut, galvanized, 3/4" IG, for type 1600

Item 4110-325



Floater for flow meter made from stainless steel for type 1000

Item 4100-330



Floater for flow meter made from stainless steel for type 1500

Item 4100-331



Floater for flow meter made from stainless steel for type 1600

Item 4110-330



Rubber sealing

Item	for Screw fitting
------	-------------------

4100-340	INSIDE	4100-320/4100-321
4110-340	INSIDE	4110-320
4110-341	OUTSIDE	4100-321/4110-320



Magnetic valve / solenoid valve

0-10 bar,
suitable universal for plastering machine, continuous mixer etc.

1/2"

Item	voltage	current
4100-027	24 V	AC
4100-029	24 V	DC
4100-030	42 V	DC
4100-035	230 V	AC

3/4"

4100-024	24 V	DC
4100-025	42 V	AC
4100-026	230 V	AC



Strainer filter for Geka coupling

Item 4100-034



Stopcock 1/2" without drain valve, brass hot-pressed with green handwheel

Item 4100-050



Needle valve 1/2"

Item 4100-051



Fine adjustment valve

Item	size
4100-053	1/2"
4100-054	3/4"



Pressure reducer 1/2" with screw sieve-cup

Item 4100-031



Pressure reducer D06FN1/2 B with brass sieve-cup

Item 4100-032



Sealing ring for pressure reducer

Item 4100-033



Sieve for pressure reducer

Item 4100-036



Sieve-cup transparent 1/4" IG for pressure reducer

Item 4100-037



Sieve-cup brass 1/4" IG for pressure reducer

Item 4100-038



Ball valve 1/4" IG/AG application up to 90°, PN10

Item 4100-048



Pressure switch type FF4-4 0,22-4 bar

Item 4100-070



NOTE: All spare parts also suitable for Honeywell.

Manometer and protection caps



Mortar pressure gauge

Manometer 0-16 bar
connection 1/4" below,
diameter 63 mm
use: plastering machine

Item 4100-040



Manometer 0-6 bar
connection 1/4" back,
diameter 63 mm
use: plastering machine

Item 4100-041



Manometer 0-16 bar
connection 1/4" back,
diameter 63 mm
use: plastering machine

Item 4100-042



Manometer 0-4 bar
connection 1/4" below,
diameter 63 mm
use: conveyor system

Item 4100-920



Glycerin-Manometer 0-100 bar
connection 1/4" below,
diameter 63 mm
use: mortar pressure

Item 4100-045



Glycerin-Manometer 0-100 bar
connection 1/4" back,
diameter 63 mm
use: mortar pressure

Item 4100-046



Glycerin-Manometer 0-16 bar
connection 1/4" back,
diameter 63 mm
use: screed pump

Item 4230-300



Rubber protection cap for Manometer
for connection back und below,
diameter 63 mm

Item 4100-044



Rubber protection cap for Glycerin-Manometer
for connection back und below,
diameter 63 mm

Item 4100-047



Manometer VARIO 0-100 bar, without protection bar, connection below

Item	VT	suitable for
4100-281	35	25/35
4100-282	50	50



Manometer VARIO 0-100 bar, without protection bar, connection back

Item	VT	suitable for
4100-283	35	25/35
4100-284	50	50



Manometer VARIO 0-100 bar, with protection bar, connection back

Item	VT	suitable for
4100-285	35	25/35
4100-286	50	50



Mortar pressure gauge VARIO 0-100 bar, without protection bar, connection below

Item	type
4100-210	MK 25
4100-211	MK 35
4100-212	MK 50
4100-214	IG 1 1/4"
4100-215	IG 2"
4100-217	AG 1 1/4"
4100-218	AG 2"



Mortar pressure gauge VARIO 0-100 bar, without protection bar, connection back

Item	type
4100-220	MK 25
4100-221	MK 35
4100-222	MK 50
4100-224	IG 1 1/4"
4100-225	IG 2"
4100-227	AG 1 1/4"
4100-228	AG 2"



Mortar pressure gauge VARIO 0-100 bar, with protection bar, connection back

Item	type
4100-230	MK 25
4100-231	MK 35
4100-232	MK 50
4100-234	IG 1 1/4"
4100-235	IG 2"
4100-237	AG 1 1/4"
4100-238	AG 2"



Mortar pressure gauge FIX 0-100 bar, without protection bar

Item	type
4100-200	MK 25
4100-201	MK 35
4100-202	IG/IG
4100-203	AG/AG



Mortar pressure gauge FIX 0-100 bar, with protection bar

Item	type
4100-205	MK 25
4100-206	MK 35
4100-207	IG/IG
4100-208	AG/AG



Pressure flanges and swivel castors



Pressure flange D-pump

forged,
with thread nipple 1 1/4" AG,
for G4, VR6, M5

Item 4100-011



Pressure flange D-pump
with tension rod and MT35
forged, for G4, VR6, M5

Item 4100-010



Pressure flange D-pump
with tension rod and MT35
for S48, VR8, M1

Item 4100-013



Tension rod M16x360
galvanised, with nuts,
for G4, VR6, M5

2 pcs

Item 4100-012



Swivel castor 230 mm
pin diameter 22 mm,
for G4, VR6, M5

Item type

- 4100-060 without brake
- 4100-061 with brake



Swivel castor 200 mm
pin diameter 22 mm,
for G4, VR6, M5

Item type

- 4100-062 without brake
- 4100-063 with brake



Swivel castor 200 mm
pin diameter 27 mm,
for S48, VR8, M1

Item type

- 4110-060 without brake
- 4110-061 with brake



Spare parts for plastering machines

Cover hood

for plastering machines G4, VR6, M5
made of robus PVC material,
protects the machine from moisture outdoors

Item 4100-850



Sealing mixing tube
for tilt flange
sponge rubber 20x15x750 mm

Item 4100-020



Sealing outlet opening
for cellular wheel/mixing tube
sponge rubber 20x15x600 mm

Item 4100-021



Sealing cleaning opening
15x10x500 mm

Item 4100-022



Filter bag

Item	version	diam.	length
4100-401	multiple bags	200 mm	500 mm
4100-400	single bag	405 mm	1100 mm



Filter strap

Item	diam.
4100-410	205 mm
4100-411	424 mm



External sealing
for injection hood,
sponge rubber 20x15x2400 mm

Item 4100-421



Spare parts and wear parts

Spare parts and wear parts

Electrical connectors



Electrical cables and distributors

Spare parts and wear parts

Spare parts and wear parts

CEE-plug, 400 V, 6 h

10 pcs in a box

Item	type
3020-416	4x16 A
3020-516	5x16 A
3020-532	5x32 A



CEE-coupling, 400 V, 6 h

10 pcs in a box

Item	type
3021-416	4x16 A
3021-516	5x16 A
3021-532	5x32 A



CEE-plug phase inverter, 400 V, 6 h

10 pcs in a box

Item	type
3022-516	5x16 A
3022-532	5x32 A



Rubber plug 230 V

10 pcs in a box

Item 3020-230



Rubber coupling 230 V

10 pcs in a box

Item 3021-230



Rubber coupling 3-way 230 V

10 pcs in a box

Item 3021-233



Adapter rubber plug 230 V, socket CEE 3x16 A

10 pcs in a box

Item 3025-230



CEE adapter plug CEE 5x16 A, socket 5x32 A

10 pcs in a box

Item 3025-532



Construction cable K35

type AT-N07V3V3-F, imprint available on request

50 m per bundle

Item	type
------	------

3000-315	3x1,5 mm ²
3000-525	5x2,5 mm ²



Construction cable K35 with CEE-plug and coupling

checked, type AT-N07V3V3-F

Item	type	Ampere	bundle
3005-025	5x2,5 mm ²	32 A	25 m
3006-025	5x2,5 mm ²	16 A	25 m
3007-025	5x4,0 mm ²	32 A	25 m



Construction cable K35 with Schuko-plug and coupling

checked, type AT-N07V3V3-F

Item	type	bundle
3001-010	3x1,5 mm ²	10 m
3001-025	3x1,5 mm ²	25 m



Probe cable 3x1,5 mm² complete

K35, incl. probe plug and probe coupling CEE 3x16A 12h

Item	bundle
------	--------

4100-950	25 m
4100-951	50 m



Probe plug and coupling

42V, 3x16 A 12 h, white

Item	type
------	------

4100-952	probe plug
4100-953	probe coupling



Electric distributor small with 2 m supply cable

input 5x32 A, output 3 pcs 5x32 A

Item 3029-032



Electric distributor without fuse and with 2 m supply cable

2 pcs 5x16 A, 4 pcs 230 V

Item 3029-016



Remote control and spare parts



Spare parts for conveyor

Spare parts and wear parts

Spare parts and wear parts

Extension for remote control cable with HAN 3A

Item	length
4100-990	16,6 m
4100-991	25 m
4100-992	50 m



Remote control switch with 75 cm cable and holder with plug HAN 3A

Item 4100-999



Plug remote control 3+1-pole, 10A, with housing, cablescrew fitting with bending spiral

Item 4100-970



Vibrating motor for silo 400 V, 50 Hz, 0,20 kW, with 5 m rubber cable without plug, 3.000 rpm, 2-pole, imbalance force 3,11 kN, weight 10,4 kg

Item 4100-980



Filling level indicator round for the controlling of the conveyor, with on/off-switch, 42 V, assembly drilling 48 mm, redary wing with plug

Item 4100-961



Emulsifier SET for pressure vessel complete 1 piece each large perforated plate, small perforated plate, framing sealing

Item 4100-961

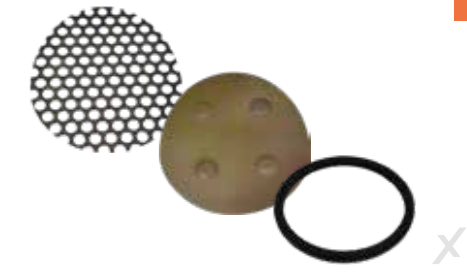

Coupling remote control 3+1-pole, 10A, with housing, cablescrew fitting with bending spiral

Item 4100-971



Plug housing ALU 3+1-pole, straight with 2 bolts

Item 4100-972



Plug insert 3+1-pole, 10A, 230V

Item 4100-973



Large perforated plate Emulsifier

Item 4100-915

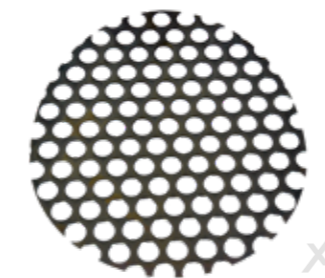

Small perforated plate Emulsifier

Item 4100-916



Framing sealing Emulsifier

Item 4100-917



Coupling housing ALU 3+1-pole, straight with clip

Item 4100-974



Coupling insert 3+1-pole, 10A, 230V

Item 4100-975



Skintop screw fitting M 20x1,5, with bending spiral

Item 4100-979



Cuff 250 mm for shut-off damper, Polyurethan, green

Item 4100-910



Rubber sealing pressure vessel 330x260x4 mm

Item 4100-900

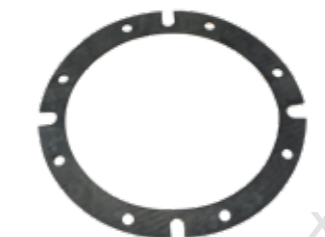

Stators and rotors



Stator D6-3 DRILL orange
maintenance-free,
with anti-redation pin,
approx. 20 l/min. with 400 rpm,
grain size up to 3 mm

10 pcs in a box

Item 4000-640

Rotor D6-3
highly wear-resistant

Item 4000-630

SET Item 4000-642



Stator D6-3 SLIMFIT orange
maintenance-free,
without anti-redation pin,
approx. 20 l/min. with 400 rpm,
grain size up to 2 mm

10 pcs in a box

Item 4000-621

Rotor D6-3 SLIMFIT
highly wear-resistant

Item 4000-620

SET Item 4000-622



Stator D6-3 orange
maintenance-free,
with anti-redation pin,
approx. 20 l/min. with 400 rpm,
grain size up to 3 mm

10 pcs in a box

Item 4000-631

Rotor D6-3
highly wear-resistant

Item 4000-630

SET Item 4000-641



Stator DRILL D7-2,5 creme-white
maintenance-free,
with anti-redation pin,
approx 30 l/min. with 400 rpm,
grain size up to 3 mm

10 pcs in a box

Item 4000-723

Rotor D7-2,5
highly wear-resistant

Item 4000-720

SET Item 4000-727



Stator PFT TWISTER D6-3
maintenance-free,
with anti-redation pin,
approx. 20 l/min. with 400 rpm,
grain size up to 3 mm

10 pcs in a box

Item 4000-637

Rotor D6-3
highly wear-resistant

Item 4000-630

SET Item 4000-645



Stator D7-2,5 creme-white
maintenance-free,
with anti-redation pin,
approx 30 l/min. with 400 rpm,
grain size up to 3 mm

10 pcs in a box

Item
4000-721
4000-722 Edition ZERO

Rotor D7-2,5
highly wear-resistant

Item 4000-720

SET
Item
4000-729
4000-728 Edition ZERO



Stator D8-2 black
maintenance-free,
with anti-redation pin,
approx. 32 l/min. with 400 rpm,
grain size up to 3 mm

10 pcs in a box

Item 4000-821

Rotor D8-2
highly wear-resistant

Item 4000-820

SET Item 4000-829



T-key universal
for turning the rotor
in and out

Item 4000-400



Stator D8-1,5 yellow
maintenance-free,
with anti-redation pin,
approx 35 l/min. with 400 rpm,
grain size up to 3 mm

10 pcs in a box

Item 4000-811

Rotor D8-1,5
highly wear-resistant

Item
4000-810
4000-815 with Zapfen

SET Item 4000-819 with Rotor 4000-810



Silicone spray 400 ml
easy installation without
exertion, no sticking,
acid free

12 pcs in a box

Item 4000-400



Stators and rotors

Stator DRILL D4-3 half power, green
maintenance-free,
with anti-redation pin,
approx. 12 l/min. with 400 rpm,
grain size up to 4 mm

10 pcs in a box

Item 4000-416

Rotor D4-3 1/2 Leistung
highly wear-resistant

Item 4000-415

SET Item 4000-417



Stators and rotors



Stator 2L6

maintenance-free, 60 Shore, approx. 60 l/min. with 400 rpm, length 534 mm, diameter 101 mm, grain size up to 6 mm, for Putzmeister S5, S11, PFT ZP3, silo mixing pump

Item type

- 4010-265 with pin
- 4010-266 with clamping bar
- 4010-267 with slots

Rotor 2L6

53 mm head with drilling and slots

Item 4010-261



Stator 2L74

maintenance-free, 60 Shore, with pin, approx. 320 l/min. with 400 rpm, length 666 mm, diameter 124 mm, grain size up to 8 mm, for truck mixer pump and diesel machines

Item 4009-275

Rotor 2L74

highly wear-resistant, head with drilling

Item 4009-271



Stator 2L6+++

maintenance-free, 73 Shore, with clamping bar, approx. 110 l/min. with 400 rpm, length 534 mm, diameter 101 mm, grain size up to 6 mm, for Putzmeister S5, S11, PFT ZP3, silo mixing pump

Item 4010-276

Rotor 2L6+++

highly wear-resistant, head with drilling and slots

Item 4010-271



Stator 7515

maintenance-free, 63 Shore, type 1,5 L7, approx. 300 l/min. with 400 rpm, length 550 mm, diameter 159 mm, grain size up to 8 mm, for truck mixer pump and diesel machines

Item type

- 4010-755 with pin
- 4010-756 with clamping bar

Rotor 7515

highly wear-resistant, head hexagonal

Item 4010-750



Stators and rotors

Stator 2L8

maintenance-free, 63 Shore, with clamping bar approx. 450 l/min. with 400 rpm, length 650 mm, diameter 190 mm, grain size up to 10 mm, for truck mixer pump and diesel machines

Item 4010-286

Rotor 2L8

highly wear-resistant, head hexagonal

Item 4010-280



Joint discs

strength 30 mm

Item Outer diameter

- 4290-300 132 mm
- 4290-301 162 mm



Mixing blades type 4200

INNOXAT

Mixing blade holder P1 back
back, outside

Item 4200-001



Mixing blade holder P2 front
front, gear side

Item 4200-002



Mixing blade P3 back
back, outside,
steel casting

Item 4200-003



Mixing blade P4 middle
middle,
steel casting

Item 4200-004



Mixing blade P5 front
front, gear side,
steel casting

Item 4200-005



Mixing blades type 4200

Mixing tool 4200 complete, middle outlet
for Putzmeister, Brinkmann, BMS, EMS, GB, Utiform etc.

included:

2x Holder P1
2x Holder P2
1x Mixing blade P3
2x Mixing blade P4
1x Mixing blade P5
screw kit

Item 4200-008

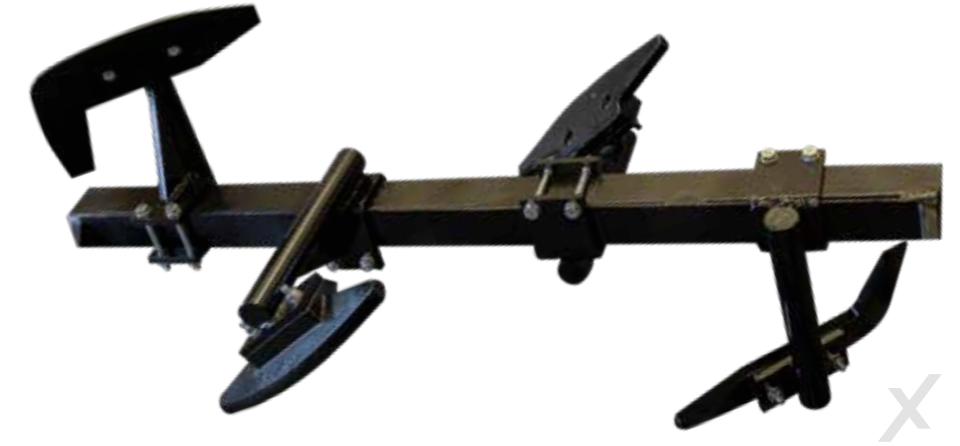

Mixing tool 4200 complete, front outlet
for Putzmeister, Brinkmann, BMS, EMS, GB, Utiform etc.

included:

3x Holder P1
1x Holder P2
1x Mixing blade P3
2x Mixing blade P4
1x Mixing blade P5
screw kit

Item 4200-009



Screw kit complete
48 parts,
suitable for mixing tool 4200

Item 4800-001



Mixing blades type 4230

INNOXAT

Mixing blades type 4230

Mixing blade X1 front
front, gear side,
steel casting

Item 4230-001



Mixing bracket X4
(Mixing blade holder)

Item 4230-004



Covering plate
for mixing bracket X4

Item 4230-006



Mixing blade X3 back
back, outside,
steel casting

Item 4230-003



Mixing bracket X5

Item 4230-005



Mixing tool 4230 complete, outlet middle
for Putzmeister, Brinkmann, BMS, EMS, GB, Utiform etc.

included:

4x Mixing bracket X4
4x Mixing bracket X5
2x Mixing blade X1
2x Mixing blade X3
4x Covering plate
Screw kit

Item 4230-008



Mixing tool 4230 complete, outlet front

incl. screws,
for Putzmeister, Brinkmann, BMS, EMS, GB, Utiform etc.

included:

4x Mixing bracket X4
4x Mixing bracket X5
1x Mixing blade X1
3x Mixing blade X3
4x Covering plate
Screw kit

Item 4230-009



Screw kit complete

36 parts,
suitable for mixing tool 4230

Item 4800-002



Spare parts and wear parts

Spare parts and wear parts

Mixing blade holder Ü1
right outside,
for Ülzener

Item 4210-001



Mixing blade holder Ü2
left gear side,
for Ülzener

Item 4210-002



Mixing blade Ü3
right outside,
for Ülzener

Item 4210-003



Mixing blade Ü4
middle,
for Ülzener

Item 4210-004



Mixing blade Ü5
left gear side,
for Ülzener

Item 4210-005



Screw kit complete
40 parts,
suitable for mixing tool 4210,
for Ülzener

Item 4800-003



Wear plate
without outlet, 48x33 cm,
with 2 drillings,
thickness 8 mm, steel,
for Ülzener

Item 4210-010



Wear plate
without outlet, 48x33 cm,
with 4 drillings,
thickness 8 mm, steel,
for Ülzener

Item 4210-011



Wear plate
with outlet, 48x33 cm,
with 4 drillings,
thickness 8 mm, steel,
for Ülzener

Item 4210-012



Wear plate
without outlet, 22 cm,
with 2 drillings,
for Putzmeister and Brinkmann

Item	thickness	material
4200-010	6 mm	steel
4190-610	6 mm	Hardox
4190-810	8 mm	Hardox



Wear plate
with outlet, 22 cm,
with 2 drillings,
for Putzmeister and Brinkmann

Item	thickness	material
4200-011	6 mm	steel
4190-611	6 mm	Hardox
4190-811	8 mm	Hardox



Wear plate
longitudinal, 68x25cm
with 3 drillings,
for Putzmeister and Brinkmann

Item	thickness	material
4200-012	6 mm	steel
4190-612	6 mm	Hardox
4190-812	8 mm	Hardox



Wear plate
longitudinal, 62x25cm
with 2 drillings,
for Putzmeister and Brinkmann

Item	thickness	material
4200-013	6 mm	steel
4190-613	6 mm	Hardox



Screw kit for wear plates
4 parts,
for all established screed pumps

Item 4800-000



Wear plates for screed pumps



Wear plate

without outlet, 31 cm, with 8 drillings, for Brinkmann

Item	thickness	material
4230-010	6 mm	steel
4190-620	6 mm	Hardox

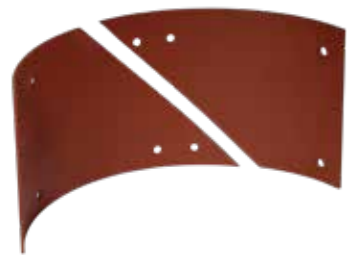

Wear plate

with outlet, 31 cm, with 8 drillings, for Brinkmann

Item	thickness	material
4230-011	6 mm	steel
4190-621	6 mm	Hardox



Wear plate

small outlet in the middle, 31 cm, with 16 drillings, for Brinkmann

Item	thickness	material
4230-012	6 mm	steel
4190-622	6 mm	Hardox



Wear plate

without outlet, longitudinal 64x25 cm, for GB Mixman

Item	thickness	material
4230-014	5 mm	steel
4190-624	6 mm	Hardox



Wear plate

with outlet in the middle, 64x25 cm, for GB Mixman

Item	thickness	material
4230-015	5 mm	steel
4190-625	6 mm	Hardox



Wear plate

with front outlet, 64x25 cm, for GB Mixman

Item	thickness	material
4230-016	5 mm	steel
4190-626	6 mm	Hardox



Filling hopper

for Putzmeister M740/1 year 1999-2002

Item 4200-031



Filling hopper big

for Putzmeister M740/2 year 2002-2007 and M740/3 year 2007-2014

Item 4200-032



Filling hopper

Filling hopper A1 right for Brinkmann DC 450/550 and Putzmeister since M740/4 year 2014

Item 4230-037



Filling hopper A2 back

for Brinkmann DC 450/550 and Putzmeister since M740 year 2014

Item 4230-031



Filling hopper small B/BS back

feeder/scrapper for Brinkmann DC 450/550 and Putzmeister since M740 year 2014

Item 4230-035



Filling hopper A1 right

for Brinkmann DC 260/43 year 1991-1999

Item 4230-032



Filling hopper A1 right

for Brinkmann DC 260/45 since year 1999 and GB Mixman

Item 4230-030



Filling hopper A2 back

for Brinkmann DC 260/45 since year 1999 and GB Mixman

Item 4230-036



Filling hopper small B/BS back

feeder/scrapper for Brinkmann DC 260/45 since year 1999 and GB Mixman

Item 4230-034



Mixing vessel outlets



Mixing vessel outlets

Vessel outlet PM
long version,
for Putzmeister

Item 4200-020



Vessel outlet PM complete
with KK70+MT35 couplings,
incl. sealing and screws,
for Putzmeister

Item 4200-021



Vessel outlet PM
short version,
for Putzmeister

Item 4200-022



Vessel outlet EB
inside micrometer 170 mm flange,
decentred outlet,
for Brinkmann DC 450/550

Item 4230-022



Vessel outlet EB complete
with KK70+MT35 couplings,
incl. sealing and screws,
for Brinkmann DC 450/550

Item 4230-023



Vessel outlet
inside micrometer
160 mm flange,
for BMS

Item 4240-020



Vessel outlet PM complete
short version,
with KK70+MT35 couplings,
incl. sealing and screws,
for Putzmeister

Item 4200-023



Vessel outlet EB
Inside micrometer 160 mm flange,
centred outlet,
for Brinkmann DC 260/43-45

Item 4230-020



Vessel outlet EB complete
with KK70+MT35 couplings,
incl. sealing and screws,
for Brinkmann DC 260/43-45

Item 4230-021



Vessel outlet complete
with KK70+MT35 couplings,
for BMS

Item 4240-021



Vessel outlet
2 1/2" AG,
1 1/4" AG,
for Ülzener

Item 4210-020



Vessel outlet complete
with KK70+VT35 couplings,
incl. sealing and screws,
for Ülzener

Item 4210-021



Spare parts and wear parts

Spare parts and wear parts

Air hoses and check valves



Ball valves for screed pumps

Upper air hose 25 mm
with 2 fixing claw couplings,
steel belt mounting

Item	length incl couplings
4270-029	29 cm
4270-032	32 cm
4270-043	43 cm
4270-094	94 cm
4270-120	120 cm



Lower air hose 25 mm
with fixing claw coupling
and VT35/nozzle,
steel belt mounting

Item	length incl couplings
4271-079	79 cm
4271-094	94 cm
4271-120	120 cm
4271-145	145 cm



Lower air hose 25 mm
with 1 1/4" AG, nozzle and
fixing claw coupling,
steel belt mounting

Item	length incl couplings
4272-089	89 cm
4272-115	115 cm
4272-140	140 cm



Ball valve
passage 30 mm,
dimension 52 mm,
for Putzmeister

Item 4290-030



Sealing ring for ball valve
passage 30 mm,
dimension 30x47 mm,
for Putzmeister

Item 4290-031



Rückschlagventil 1"

Item 4290-020



Sealing cone
70x33 mm

Item 4290-060



Ball valve

IG/IG, brass, PN 25
with handle made of steel, full passage,
application -20° to 150°

Item	dimension
4290-035	1"
4290-036	1 1/4"

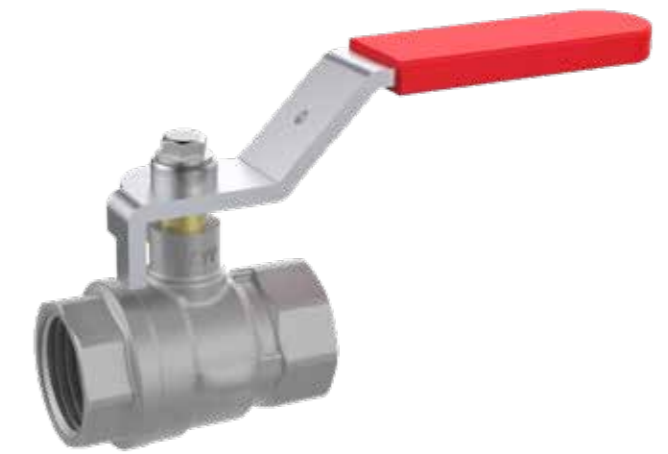

Ball valve

1" IG/IG, PN 40,
with handle made of aluminium, black,
full passage,
application -20° to 150°

Item 4290-045



Ball valve

1 1/4" IG/AG, PN 25,
with handle made of steel,
full passage,
application -20° to 150°

Item 4290-039



Ball valve (cover ventilation)
1 1/4" IG/IG, PN 40,
with handle made of aluminium,
black and grease nipple

Item 4290-037



Ball valve (cover ventilation)

1 1/4" IG/AG,
with handle made of aluminium,
black and grease nipple

Item 4290-038



Corner ball valve

1" IG/AG, PN 40,
with handle made of aluminium

Item 4290-040



handle black ALU

for corner ball valve 1" IG/AG

Item 4290-041



Cover sealing and mixing shafts



Cover sealing

22x8x1160 mm,
for Putzmeister, Brinkmann, BMS and GB

Item 4200-050



Mixing shaft

length 1242 mm,
for Putzmeister
old version

Item 4200-100



Mixing shaft

length 1365 mm,
for Brinkmann DC 260/43-45
and BMS

Item 4230-100

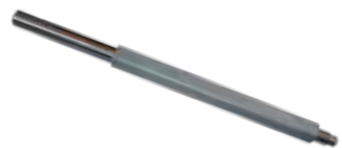

Mixing shaft

length 1270 mm,
for Putzmeister M 740

Item. 4200-110



Mixing shaft

length 1365 mm,
for Brinkmann DC 450/550
and BMS

Item 4230-110



Wear sleeve

70x60x125 mm,
for Putzmeister

Item 4200-115



Shaft seal

40x62x6 mm, back,
for Putzmeister

Item 4200-130



Sleeve

70,8x95,6x40 mm,
gear side,
for Putzmeister

Item 4200-126



Rubber disc

for Putzmeister

Item	dimension	type
------	-----------	------

4200-120	170x64x8 mm	vessel inside B/F
4200-121	180x66x4 mm	
4200-122	140x36x8 mm	vessel inside B



Bearing flange

sleeve,
for Putzmeister

Item 4200-140



Sleeve

40,7x64,5x40 mm,
backside bearing,
for Putzmeister

Item 4200-127



Bearings for screed pumps

U-ring

70x95x18,7 mm,
for Putzmeister

Item 4200-125



Bearing flange

back complete,
for Putzmeister

Item 4200-141



Rubber sealing

6x13 mm,
for Brinkmann, BMS

Item	dimension
------	-----------

4230-120	170x50x10 mm
4230-121	170x60x10 mm



Bearing flange

gear side,
for Putzmeister

Item 4200-145



Bearings for screed pumps

Felt strip

6,5x8x260 mm,
for Brinkmann, BMS

Item 4230-125



Shaft seal

80x11x58 mm,
for Brinkmann, BMS

Item 4230-126



Packing gland

70x90x30 mm,
for Brinkmann, BMS

Item 4230-127



Inside ring

for Brinkmann, BMS

Item	dimension
4230-129	60x70x95 mm
4230-130	60x70x60 mm
4230-131	50x58x40 mm
4230-132	50x58x22 mm
4230-133	60x70x28 mm
4230-134	60x68x35 mm



Clamping sleeve

40x85x85 mm,
for Brinkmann, BMS

Item 4230-135



Bearing, mixing shaft

backside 7208B,
for Brinkmann, BMS

Item 4230-136



Bearing, mixing shaft

gear side,
for Brinkmann, BMS

Item 4230-137



Centering flange

gear side,
for Brinkmann, BMS

Item 4230-140



Flanged housing

F 513 gear side,
for Brinkmann DC 450
and GB Mixman

Item 4230-141



Bearings and spare parts for screed pumps

Bearing flange

backside,
without accessories,
for Brinkmann, BMS

Item 4230-145



Flange for
self-aligning ball bearing
for Brinkmann, BMS

Item	type
4230-146	gear side
4230-148	backside



Flange cover for
self-aligning ball bearing
gear side,
for Brinkmann, BMS

Item 4230-147



Flange cover for self-aligning ball bearing

backside,
for Brinkmann, BMS

Item 4230-149



Compressor coupling

for Brinkmann, Putzmeister,
DC 260/45/55/450/550, M740

Item 4230-200



Compressor coupling
for Brinkmann, Putzmeister,
DC 260/42, PM 3241

Item 4230-201



Powerband

for Brinkmann, Putzmeister, BMS

Item	type	length
4230-250	DC 260/45	1450 mm
4230-251	DC 450	1250 mm
4230-252	PM M740	1147 mm
4230-253	BMS Worker No. 1	1800 mm



Scraper wire rope

diameter 8 mm, length 12 m,
45,40 kN, EN 12385-4,
1690 N/mm² with thimble RW10,
sharply soldered

Item 4290-050



Tapered grease nipple
AM 10x1, DIN71412

Item 4290-800





ULTRALIGHT 50 mm
Page 69



ULTRALIGHT 35 mm
Page 71



ULTRALIGHT 19 mm
Page 73



ULTRALIGHT FREE FLOW
Page 74



MT35 1/4" 360°
Page 82



VT 360°
Page 82



MT steel AG
Page 83



VT steel AG
Page 83



Discharge stand steel ITA
Page 95



Water gun PRO
Page 99

Explanation:

MT = female coupling
VT = male coupling

IG = internal thread
AG = external thread

Hoses and couplings

66-99

Mortar hoses ULTRALIGHT	68
Delivery hoses	74
Storz couplings	75
Mortar hoses	76
Pouring hoses	80
Mortar hoses screed	81
Mortar couplings system 22	82
Mortar couplings system 23,5	85
Hose nozzles and accessories for mortar couplings	86
Cardan couplings KK70 and Stone trap	88
Cardan couplings KK89	90
Hose accessories	91
Discharge stands and accessories	92
Air and water hoses	96
Claw couplings	98

All products labelled with X are from our own production or are produced exclusively for us according to our specifications.

Mortar hose ULTRALIGHT



Dimensionally stable textile hose made of polyester with inside rubber coating and external PVC-coating.

Suitable for plastering machines, foam concrete, polystyrene concrete, flowing screed, water pumps, etc.
Not suitable for pumping cement screed, concrete, sandblasting grit, etc.

- approx. 60-70% weight saving compared to conventional rubber hoses
- pressure 40 bar
- with anti-kink spring

Inner diameter	weight per m	Bending radius
19 mm	160 g	100 mm
25 mm	280 g	150 mm
35 mm	410 g	180 mm
42 mm	510 g	250 mm
50 mm	620 g	300 mm



Mortar hose ULTRALIGHT 50 mm

- hydraulic mounting
- just 620 g/m
- pressure 40 bar
- inner diameter 50 mm
- with anti-kink spring



with 2 nozzles 2" AG

Item	weight	bundle
3224-510	8,2 kg	10 m
3224-520	14,4 kg	20 m



with MK50 VT/MT couplings

Item	weight	bundle
3224-511	10,0 kg	10 m
3224-521	16,2 kg	20 m



Hose bend 50 mm
length 70 cm,
MK50 with anti-kink spring and
hose holder textile

Item 3200-150



Hoses and couplings

Hoses and couplings

Mortar hoses ULTRALIGHT 42 mm



Mortar hoses ULTRALIGHT 35 mm



- hydraulic mounting
- just 510 g/m
- pressure 40 bar
- inner diameter 42 mm
- nozzle flow passage 40,5 mm
- with anti-kink spring



- double steel belt
- just 410 g/m
- pressure 40 bar
- inner diameter 35 mm
- with anti-kink spring

with 1 nozzle 2" AG

Item	weight	bundle
3223-410	5,5 kg	10 m
3223-420	10,5 kg	20 m

with MK50 MT coupling system 22

Item	weight	bundle
3223-411	6,5 kg	10 m
3223-421	11,5 kg	20 m

with MK50 VT coupling system 22

Item	weight	bundle
3223-412	6,3 kg	10 m
3223-422	11,3 kg	20 m

with 2 nozzles 2" AG

Item	weight	bundle
3224-310	4,8 kg	10 m
3224-320	8,9 kg	20 m

with MK35 VT/MT couplings

Item	weight	bundle
3224-311	6,1 kg	10 m
3224-321	10,2 kg	20 m

Hose bend 35 mm
length 60 cm,
MK35 with anti-kink spring and
hose holder textile

Item 3200-135

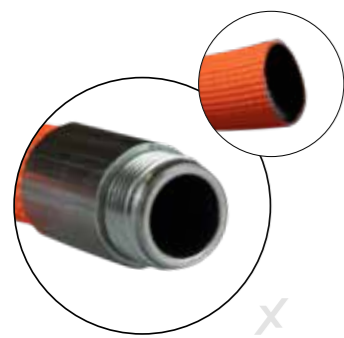

with 2 nozzles 2" AG

Item	weight	bundle
3224-410	6,0 kg	10 m
3224-420	11,0 kg	20 m

with MK50 VT/MT couplings beidseitig system 22

Item.	weight	bundle
3224-411	7,8 kg	10 m
3224-421	12,8 kg	20 m

Hose bend 42 mm
length 70 cm,
MK50 with anti-kink spring and
hose holder textile

Item 3200-142

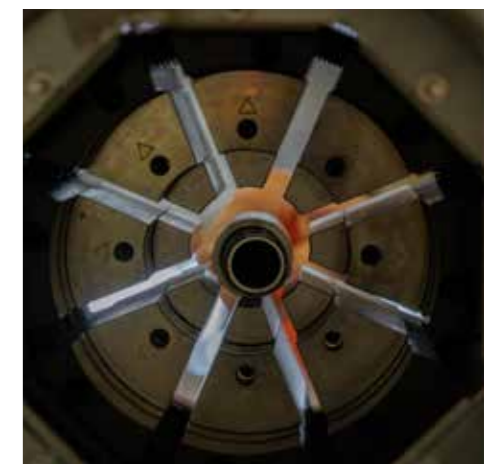
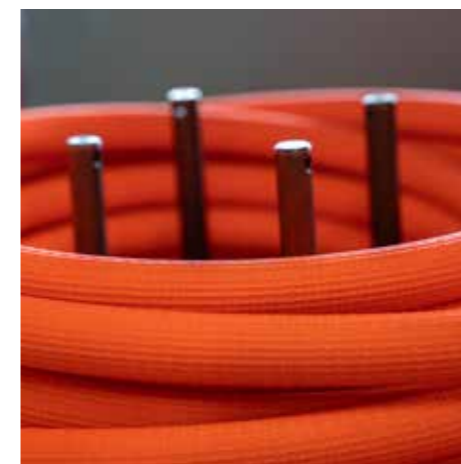

Hoses and couplings

Hoses and couplings

Mortar hoses ULTRALIGHT 25 mm



Mortar hoses ULTRALIGHT 19 mm



- hydraulic mounting
- just 280 g/m
- pressure 40 bar
- inner diameter 25 mm
- nozzle flow passage 23,9 mm
- with anti-kink spring



with nozzle 1" AG

Item	weight	bundle
3221-105	2,1 kg	5 m
3221-110	3,7 kg	10 m
3221-115	5,3 kg	15 m

with steel MK25 coupling

Item	weight	bundle
3221-005	3,1 kg	5 m
3221-010	4,7 kg	10 m
3221-015	6,3 kg	15 m

with ALU MK25 coupling

Item	weight	bundle
3221-205	2,6 kg	5 m
3221-210	4,2 kg	10 m
3221-215	5,8 kg	15 m



with ALU MT 360° coupling

Item	weight	bundle
3221-505	2,7 kg	5 m
3221-510	4,3 kg	10 m
3221-515	5,4 kg	15 m

with ALU VT 360° coupling

Item	weight	bundle
3221-605	2,7 kg	5 m
3221-610	4,3 kg	10 m
3221-615	5,9 kg	15 m

Hose bend 25 mm

Länge 60 cm,
MK25 with anti-kink spring and
hose holder textile

Item 3200-125



Mortar hose ULTRALIGHT 19 mm with 2 GEKA+ couplings

double steel belt, just 160 g/m, pressure 40 bar,
inner diameter 19 mm, with anti-kink spring

Item weight bundle

3220-305	1,47 kg	5 m
3220-310	2,66 kg	10 m



Delivery hoses



Delivery hose 42 mm ULTRALIGHT FREE FLOW

up to 70% weight saving, up to 10% faster delivery times, up to 15% longer hose lines possible, material can flow through unhindered, flexible and dimensionally stable even in cold conditions and over edges, protects the conveyed material, pressure 10 bar, size 42x6 mm

Item	weight	bundle
3424-410	4,8 kg	10 m
3424-413	6,8 kg	13 m
3424-420	8,0 kg	20 m



Hose bend 42 mm
length 70 cm,
Storz C-coupling with anti-kink
spring and hose holder textile

Item 3200-141



**Rubber delivery hose 42 mm
with Storz C-coupling and
clamps**
size 42x6 mm,
pressure 10 bar

Item	weight	bundle
3413-010	11,7 kg	10 m
3413-013	15,3 kg	13,3 m
3413-020	22,6 kg	20 m
3413-026	29,1 kg	26,6 m



**Rubber delivery hose 50 mm
with Storz C-coupling and
clamps**
size 50x6 mm,
pressure 10 bar

Item	weight	bundle
3415-013	17,9 kg	13,3 m
3415-020	26,5 kg	20 m



Rubber delivery hose 42 mm FREE FLOW

mounted on barrier-free C-coupling, cleat ALU forged, full passage, no danger of being blocked, no wear of the nozzles (steel inside), fast transport, longer hose lines possible, protects the transported material, pressure 10 bar, dimension 42x6 mm

Item	weight	bundle
3414-010	12,3 kg	10 m
3414-013	16,0 kg	13,3 m
3414-020	23,2 kg	20 m
3414-026	30,4 kg	26,6 m



Rubber delivery hose

black, high abrasion resistance

40 m per bundle

Item	size	weight	pressure
3410-042	42x6 mm	1,09 kg	10 bar
3410-050	50x6 mm	1,28 kg	6 bar



Storz couplings

**Storz coupling
aluminium cast with nozzle**
PN 10, NBR sealing,
nozzle length 90 mm, KA 66 mm

Item	nozzle	type
3450-045	45 mm	C-45
3450-050	52 mm	C-52



**Storz fixed coupling
aluminium cast IG 2"**
PN 10, NBR sealing,
KA 66 mm

Item 3462-050



**Storz fixed coupling
aluminium cast AG**
PN 10, NBR sealing,
KA 66 mm, dimension 2",
type C-50

Item 3472-050



**Storz blind coupling
aluminium cast with chain**
NBR sealing, KA 66 mm,
type C-66

Item 3478-066



**Storz spare sealing
NBR black**
for suction and pressurized operation,
KA 66 mm, type 52C-66

Item 3694-066



Storz coupling key B-C
steel with PVC coating

Item 3695-100



**C-coupling FREE FLOW
mounting outside**
full passage, coupling system
wear-free and no danger of blockage,
cleat ALU forged, steel nozzle,
dimension 42/54 mm,
type C-52, KA 66 mm

Item 3500-042



**Sheet metal screw
for C-coupling FREE FLOW**
4,8x13 mm with TORX head

Item 3260-002





Item	dimension	weight per m	bundle
3200-019	19x6 mm	0,55 kg	40 m
3200-022	22x6 mm	0,69 kg	40 m
3200-025	25x7 mm	0,71 kg	60 m
3200-030	30x6 mm	0,86 kg	40 m
3200-035	35x7 mm	1,16 kg	40 m
3200-040	40x8 mm	1,67 kg	40 m
3200-048	50x9 mm	2,03 kg	60 m
3200-049	50x9 mm	2,03 kg	40 m
3200-050	50x9 mm	2,03 kg	20 m

Rubber mortar hose, 10 bar
high abrasion resistance, black

Item	dimension	weight per m	bundle
3200-052	50x9 mm	2,00 kg	20 m
3200-060	60x10 mm	2,50 kg	20 m
3200-061	60x10 mm	2,50 kg	40 m
3200-065	65x10 mm	3,90 kg	20 m



Rubber mortar hose, 40 bar
high abrasion resistance, white,
Advantages: no black strokes on the wall,
mortar is not strongly heated by direct sunlight

40 m per bundle

Item	dimension	weight per m
3200-026	25x7 mm	0,71 kg
3200-051	50x9 mm	2,03 kg



Mortar hose 25 white with MK VT25/MT25 system 22,
mounted hydraulically,
dimension 25x7 mm,
pressure 40 bar

Item	weight	bundle
3216-205	5,1 kg	5 m
3216-210	8,7 kg	10 m
3216-215	12,2 kg	15 m
3216-220	15,8 kg	20 m

Mortar hose 50 white with VT50/MT50 system 22,
mounted hydraulically,
dimension 50x9 mm,
pressure 40 bar,
weight 43,4 kg

Item	weight	bundle
3216-510	23,2 kg	10 m
3216-520	43,4 kg	20 m

Our mortar hoses are mounted hydraulically!



Mortar hoses system 22



Mortar hoses system 23,5



Mortar hose 19 with MK VT25/MT25
system 22,
mounted hydraulically,
dimension 19x6 mm, pressure 40 bar,
with thread

Item	weight	bundle
3215-005	3,1 kg	5 m
3215-010	6,6 kg	10 m
3215-015	10,0 kg	15 m
3215-020	13,5 kg	20 m

Mortar hose 25 black with MK VT25 360°/MT25
system 22,
mounted hydraulically,
dimension 25x7 mm,
pressure 40 bar

Item	weight	bundle
3215-105	5,2 kg	5 m
3215-110	8,8 kg	10 m
3215-115	12,3 kg	15 m
3215-120	15,9 kg	20 m

Mortar hose 25 black with MK VT25/MT25
system 22,
mounted hydraulically,
dimension 25x7 mm,
pressure 40 bar

Item	weight	bundle
3215-205	5,1 kg	5 m
3215-210	8,7 kg	10 m
3215-215	12,2 kg	15 m
3215-220	15,8 kg	20 m

Mortar hose 35 with MK VT35/MT35
system 23,5
mounted hydraulically,
dimension 35x7 mm,
pressure 40 bar

Item	weight	bundle
3217-310	13,6 kg	10 m
3217-313	17,5 kg	13,3 m
3217-320	25,2 kg	20 m

Mortar hose 40 with MK VT50/MT50
system 23,5
mounted hydraulically,
dimension 40x8 mm,
pressure 40 bar

Item	weight	bundle
3217-413	25,2 kg	10 m
3217-420	36,6 kg	20 m

Mortar hose 50 with MK VT50/MT50
system 23,5
mounted hydraulically,
dimension 50x9 mm,
pressure 40 bar

Item	weight	bundle
3217-510	23,1 kg	10 m
3217-513	29,9 kg	13,3 m
3217-520	43,4 kg	20 m
3217-540	84,0 kg	40 m

Mortar hose 35 with MK VT35/MT35
system 22,
mounted hydraulically,
dimension 35x7 mm, pressure 40 bar

Item	weight	bundle
3215-305	7,8 kg	5 m
3215-310	13,6 kg	10 m
3215-313	17,5 kg	13,3 m
3215-320	25,2 kg	20 m
3215-340	48,4 kg	40 m

Mortar hose 40 with MK VT50/MT50
system 22,
mounted hydraulically,
dimension 40x8 mm, pressure 40 bar,
with thread

Item	weight	bundle
3215-413	25,5 kg	13,3 m
3215-420	36,7 kg	20 m
3215-440	70,1 kg	40 m

Mortar hose 50 with MK VT50/MT50
system 22,
mounted hydraulically,
dimension 50x9 mm, pressure 40 bar

Item	weight	bundle
3215-510	23,1 kg	10 m
3215-513	29,9 kg	13,3 m
3215-520	43,4 kg	20 m
3215-540	84,0 kg	40 m



NOTE:
Mortar hose 35 can also be ordered with 360° coupling in all lengths.

system 22



system 23,5



Hoses and couplings

Hoses and couplings



Mortar hose 25 with 2x nozzle 1" AG
mounted hydraulically, dimension 25x7 mm, pressure 40 bar

Item	weight	bundle
3218-205	4,2 kg	5 m
3218-210	7,8 kg	10 m
3218-215	11,3 kg	15 m
3218-220	14,9 kg	20 m

Mortar hose 35 with 2x nozzle 1 1/4" AG
mounted hydraulically, dimension 35x7 mm, pressure 40 bar

Item	weight	bundle
3218-313	16,5 kg	13,3 m
3218-320	24,2 kg	20 m

Pouring hose one side with coupling
system 22, mounted hydraulically, pressure 40 bar

dimension 35x7 mm

Item	weight	bundle	coupling
3208-313	16,1 kg	13,3 m	VT35
3208-314	16,3 kg	13,3 m	MT35

dimension 40x8 mm

3208-412	22,8 kg	13,3 m	2" AG
3208-413	23,6 kg	13,3 m	VT50
3208-414	23,8 kg	13,3 m	MT50
3208-419	34,0 kg	20,0 m	2" AG
3208-420	34,8 kg	20,0 m	VT50
3208-421	34,9 kg	20,0 m	MT50

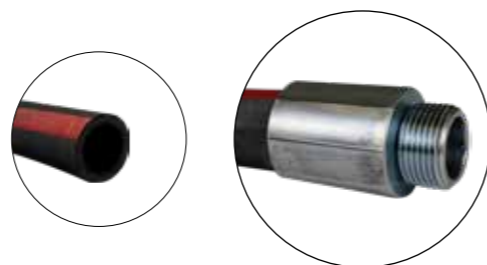

Mortar hose 50 with MK VT50/MT50

mounting outside, suitable only for screed pumps up to 10 bar, full-flow couplings, hose 40 bar, dimension 50x9 mm, length 20 m, weight 42,9 kg

Item 3210-525



Mortar hose 50 white with KK70 8-hole VT/MT coupling

mounting outside, suitable only for screed pumps up to 10 bar, full-flow couplings, hose 40 bar, dimension 50x9 mm

Item	weight	bundle
3209-520	44,4 kg	20 m
3209-540	85,0 kg	40 m

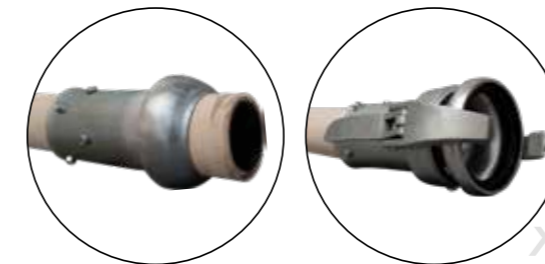

Mortar hose 50 with KK70 8-hole VT/MT coupling

mounting outside, suitable only for screed pumps up to 10 bar, full-flow couplings, dimension 50x9 mm

Item	hose	weight	bundle
3210-520	40 bar	44,4 kg	20 m
3210-540	40 bar	85,0 kg	40 m
3210-560	40 bar	125,6 kg	60 m
3210-522	10 bar	43,8 kg	20 m



Mortar hose 65 with KK89 12-hole VT/MT coupling

mounting outside, suitable only for screed pumps up to 10 bar, pressure hose 10 bar, dimension 65x10 mm

Item	weight	bundle
3210-810	42,3 kg	10 m
3210-820	81,3 kg	20 m



Mortar hose with KK70 VT/MT coupling with nozzle

mounted with double steel belt, suitable only for screed pumps up to 10 bar

Item	hose	dimension	weight	bundle
3210-620	40 bar	60x10 mm	55,2 kg	20 m
3210-710	10 bar	65x10 mm	44,7 kg	10 m
3210-720	10 bar	65x10 mm	83,7 kg	20 m



Coupling MT steel with nozzle for hydraulic mounting
system 22, with two handles,
max. pressure PN 50

Item	nozzle	MT
3250-125	25 mm	25
3250-135	35 mm	35
3250-142	42 mm	50
3250-150	50 mm	50



Coupling MT steel with nozzle for steel belt mounting
system 22, with two handles,
max. pressure PN 50

Item	nozzle	MT
3250-025	25 mm	25
3250-035	35 mm	35
3250-042	42 mm	50
3250-050	50 mm	50



Coupling MT ALU 1" IG 360°
system 22, with two handles,
max. pressure PN 40,
dimension 25 mm,
MT25, 360° rotatable

Item 3252-024



Coupling VT steel with nozzle for hydraulic mounting
system 22,
max. pressure PN 50

Item	nozzle	VT
3251-125	25 mm	25
3251-135	35 mm	35
3251-142	42 mm	50
3251-150	50 mm	50



Coupling VT steel with nozzle for steel belt mounting
system 22,
max. pressure PN 50

Item	nozzle	VT
3251-025	25 mm	25
3251-035	35 mm	35
3251-042	42 mm	50
3251-050	50 mm	50



Coupling MT35 1 1/4" IG 360°
system 22, with two handles,
max. pressure PN 40

Item 3252-036



Coupling VT steel ROTATEABLE for hydraulic mounting
system 22,
nozzle 25 mm, VT 25,
max pressure PN 50

Item 3251-126



Coupling VT steel with rotatable nozzle for steel belt mounting
system 22,
nozzle 25 mm, VT 25,
max. pressure PN 40

Item 3251-026



Coupling VT 360°
system 22,
max. pressure PN 40

Item	VT	IG	material
3253-023	25	1"	ALU
3253-038	35	1 1/4"	steel



Coupling MT ALU 1" IG
system 22, with two handles,
max. pressure PN 40,
MT25

Item 3252-023



Coupling MT steel IG
system 22, with two handles,
max. pressure PN 50

Item	MT	IG
3252-025	25	1"
3252-033	35	1"
3252-034	35	1 1/4"
3252-035	35	1 1/2"
3252-050	50	2"
3252-065	65	2 1/2" PN25!



Reduction VT/nozzle steel for steel belt mounting
system 22,
max. pressure PN 50

Item	nozzle	VT
3251-036	25 mm	35
3251-051	35 mm	50



Coupling MT PVC 1" IG
system 22, with two handles,
max. pressure PN 25,
MT25

Item 3252-026



Coupling MT steel AG
system 22, with two handles,
max. pressure PN 50

Item	MT	IG
3252-625	25	1 1/4"
3252-635	35	1 1/4"
3252-650	50	2"
3252-651	50	2 1/2"



Reduction VT/VT steel
system 22,
max. pressure PN 50

Item	VT/VT
3254-035	35/25
3254-050	50/35



Coupling VT ALU IG
system 22,
with inner thread,
max. pressure PN 40

Item	VT	IG
3253-024	25	1"
3253-037	35	1 1/2"



Coupling VT steel IG
system 22,
with inner thread,
max. pressure PN 50

Item	VT	IG
3253-025	25	1"
3253-026	25	1 1/4"
3253-033	35	1"
3253-034	35	1 1/4"
3253-035	35	1 1/2"
3253-050	50	2"
3253-051	50	2 1/2"
3253-065	65	2 1/2" PN25!



Coupling VT steel AG
system 22,
max. pressure PN 50

Item.	VT	AG
3253-625	25	1 1/4"
3253-635	35	1 1/4"
3253-650	50	2"



Hoses and couplings

Hoses and couplings

Coupling MT50

system 22,
8-hole, PN10,
for mortar hose 50/68 mm,
extended and widened hose connection part

Item 3250-056



Coupling VT50

system 22,
8-hole, PN10,
for mortar hose 50/68 mm,
extended and widened
hose connection part

Item 3251-056



Coupling MT65

system 22,
8-hole, PN10,
for mortar hose 50/68 mm,
extended and widened
hose connection part

Item 3250-066



Coupling VT65

system 22,
8-hole, PN10,
for mortar hose 50/68 mm,
extended and widened
hose connection part

Item 3251-066



Screw-in nozzle outside 2" AG

8-hole
for mortar hose 50/68 mm

Item 3257-049



Screw-in nozzle outside 2 1/2" AG

8-hole,
for mortar hose 50/68 mm

Item 3257-050



Coupling MT steel with nozzle for hydraulic mounting

system 23,5 with two handles,
max. pressure PN 50

Item	nozzle	MT
3250-635	35 mm	35
3250-650	50 mm	50



Coupling MT steel with nozzle for steel belt mounting

system 23,5 with two handles,
max. pressure PN 50

Item	nozzle	MT
3250-535	35 mm	35
3250-550	50 mm	50



Coupling MT steel IG

system 23,5 with two handles,
max. pressure PN 50

Item	MT	IG
3252-535	35	1 1/2"
3252-550	50	2"



Coupling VT steel with nozzle for hydraulic mounting

system 23,5,
max. pressure PN 50

Item	nozzle	VT
3251-635	35 mm	35
3251-650	50 mm	50



Coupling VT steel with nozzle for steel belt mounting

system 23,5,
max. pressure PN 50

Item	nozzle	VT
3251-535	35 mm	35
3251-550	50 mm	50



Coupling VT steel IG

system 23,5,
max. pressure PN 50

Item	VT	IG
3253-550	50	2"
3253-551	50	2 1/2"



system 22



system 23,5



Reduction coupling VT steel with nozzle

system 23,5,
max. pressure PN 50

Item	nozzle	VT
3251-536	25 mm	35



Nozzles and accessories



Accessories for mortar couplings

Pressing sleeve for hydraulic mounting
turned from steel, pressure PN 50

Item	dimension	dimensions O x I x L
3250-219	19 mm	38x31,5x40 mm
3250-225	25 mm	50x41x50 mm
3250-235	35 mm	58x49x55 mm
3250-242	42 mm	65x56x55 mm
3250-250	50 mm	75x68x60 mm



Hose nozzle steel AG for steel belt mounting

Item	nozzle	AG
3256-019	19 mm	1"
3256-025	25 mm	1"
3256-035	35 mm	1 1/4"
3256-042	42 mm	2"
3256-050	50 mm	2"
3256-065	65 mm	2 1/2"



Hose nozzle steel AG for hydraulic mounting

Item	nozzle	AG
3256-119	19 mm	1"
3256-125	25 mm	1"
3256-135	35 mm	1 1/4"
3256-142	42 mm	2"
3256-143	42 mm	2" for UL
3256-150	50 mm	2"



Mortar hose clampings

Item	clamping range	for hose
3270-025	36-39 mm	25 mm
3270-026	40-43 mm	25 mm
3270-035	44-47 mm	35 mm
3270-042	56-59 mm	42 mm
3270-050	64-67 mm	50 mm
3270-060	74-79 mm	60 mm
3270-065	80-85 mm	65 mm



Steel belt mounting V2A
suitable for all types of mortar and delivery hoses

Item	length	width	for hose
3275-024	32 mm	12,7 mm	25 mm
3275-025	44,5 mm	16 mm	25 mm
3275-035	57 mm	16 mm	35 mm
3275-040	64 mm	16 mm	40 mm
3275-050	76 mm	19 mm	50 mm
3275-060	89 mm	19 mm	60/65 mm



Roll pin for couplings
dimension 6x31 mm,
for type MT25, MT35,
MT50, MT65

10 pcs per pack

Item 3250-000



Hoses and couplings

Hoses and couplings

Reduction MT50/VT35
system 22,
max pressure PN 50

Item 3254-149



Cleaning coupling MK VT/claw coupl
brass claw coupling 1"

Item	VT
3253-925	25
3253-935	35
3253-950	50



Cleaning coupling MK MT/claw coupl.
brass claw coupling 1"

Item	MT
3253-936	35
3253-951	50



Sealing for MK couplings

Item	type
3255-025	MK25
3255-035	MK35
3255-050	MK50
3255-065	MK65



Sealing for KK couplings

Item	type
3255-060	KK70
3255-089	KK89



Self-drilling screws for 8-hole coupling

Item	dimension
3260-000	6,3x22 mm
3260-001	6,3x16 mm



Handle with safety ring
for type MT25, MT35,
MT50, MT65

Item 3250-002



Cardan couplings KK70



Cardan coupling KK70, mounting outside

8-hole, with cast iron lever mechanism system „Perrot“, for mortar hose, extended and widened hose connection part for easy assembly and protection of the hose, diameter 50 (68) mm

Item 3260-050 MT sleeve length 140 mm Item 3261-050 VT sleeve length 180 mm



Cardan coupling MT KK70, with nozzle for inside mounting
with cast iron lever mechanism, system „Perrot“, for mortar hose

Item	nozzle
3260-051	50 mm
3260-060	60 mm
3260-065	65 mm

Cardan coupling VT KK70, with nozzle for inside mounting
system „Perrot“, for mortar hose

Item	nozzle
3261-051	50 mm
3261-060	60 mm
3261-065	65 mm



Cardan couplings KK70 and stone trap

Stone trap for screed pump MT KK70 / VT MK50

long version,
system 22

Item 3260-101



Stone trap for screed pump MT KK70 / VT MK50

short version, 2 1/2"

Item	system
3260-100	22
3260-102	23,5



Cardan coupling MT KK70, with inner thread

with cast iron lever mechanism, system „Perrot“, for mortar hose

Item	IG
3260-061	2 1/2"
3260-063	3"



Cardan coupling VT KK70, with 2 1/2" inner thread

system „Perrot“, for mortar hose

Item 3261-061



Cardan coupling MT KK70, with 2 1/2" outer thread

with cast iron lever mechanism, system „Perrot“, for mortar hose

Item 3260-062



Cardan coupling KK89
12-hole, for outside mounting
 with cast iron lever mechanism
 system „Perrot“
 for mortar hose 65 (85) mm,
 extended and widened hose
 connection part

Cardan coupling MT KK89,
with inner thread
 with cast iron lever mechanism
 system „Perrot“,
 for mortar hose

Cardan coupling VT KK89,
with inner thread
 system „Perrot“,
 for mortar hose

Sponge rubber ball

Item	dimension	for hose	RG
3280-019	20 mm	19 mm	250
3280-025	30 mm	25 mm	250
3280-026	30 mm	25 mm	300 HARD
3280-030	35 mm	30 mm	250
3280-035	45 mm	35 mm	250
3280-040	50 mm	40 mm	250
3280-050	60 mm	50 mm	200
3280-060	70 mm	60 mm	200
3280-065	80 mm	65 mm	200



Spacer and protection ring
for the hose!

MT sleeve length 180 mm

Item 3260-066



Hose holder textile

with reinforced hook,
 perfect for the transport of hoses and cables
 and to fix mortar hoses, width 6 cm

Item	color	length inc. hook
3200-100	black	61 cm
3200-101	green	61 cm
3200-102	green	121 cm



Cardan coupling MT KK89,
with nozzle
for inside mounting
 with cast iron lever mechanism
 system „Perrot“,
 for mortar hose 65 mm

Cardan coupling VT KK89,
with nozzle
for inside mounting
 system „Perrot“,
 for mortar hose 65 mm

Hose holder leather
 with reinforced hook,
 3-times riveted,
 perfect for the transport
 of hoses and cables
 width 6 cm, length 40 cm

Protective spiral „Connect“
 for mortar hose Ultralight 25 mm,
 black,
 one spiral recommended per meter,
 weight 22 g each

Protective spiral „Connect“
 for rubber mortar hose 25 mm,
 yellow,
 one spiral recommended per meter,
 weight 37 g each

Item 3260-067

Item 3261-067

Item 3200-105

10 pcs in a box

10 pcs in a box

Item 3200-240

Item 3200-250



VT sleeve length 175 mm

Item 3261-066

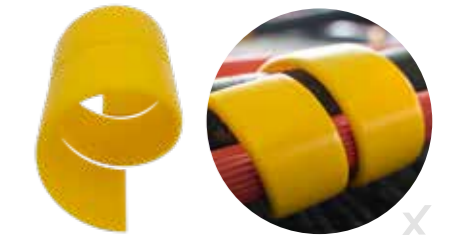



Our discharge stand impresses above all with its robustness and durability. All parts are screwed and can be easily replaced.

Hoses and couplings



2 handles, front and back, to carry with both hands.



Reinforced by internally fixed plates for maximum robustness.

Discharge stand aluminium coupling KK70
rotatable, tripod,
all parts screwed and replaceable

Item	height	bottom height
4300-001	650 mm	390 mm
4300-002	760 mm	510 mm

Discharge stand aluminium coupling MK50
rotatable, tripod,
all parts screwed and replaceable

Item	height	bottom height
4300-004	650 mm	390 mm
4300-005	760 mm	510 mm



Connection plate KK70 for discharge stands aluminium
with handle,
without chain and splint

Item 4300-502



Connection plate MK50 for discharge stands aluminium
with handle,
without chain and A-plug

Item 4300-503



A-plug
for connection plate of
discharge stands aluminium,
type MK50

Item 4300-513



Leg with rubber foot
for discharge stands
aluminium 650 mm, without screws

Item	length	type
4300-504	650 mm	without handle
4300-505	650 mm	with handle
4300-507	760 mm	without handle
4300-508	760 mm	with handle



Block chain
for connection plate of
discharge stands aluminium

Item	for	type
4300-506	KK70	with 2 splint
4300-512	MK50	with 1 splint



Adapter A50
KK70 VT / MK 50 MT
for discharge stands
4300-100/104,
with 9 cm hose

Item 3260-110



Rubber pot for discharge stands
PU white, wear-resistant

Item 4300-300



Rubber pot for discharge stands
rubber black, wear-resistant

Item 4300-301



Rubber pot drilled for discharge stands
rubber black, wear-resistant

Item 4300-302



Hoses and couplings

Discharge stands steel



Discharge stand steel and accessories

Discharge stand steel tripod
without connection plate,
bottom height rubber pot 360 mm,
stand space 70x80x80 cm

Item 4300-155



Discharge stand steel skid
without connection plate,
bottom height rubber pot 360 mm,
stand space 70x80x80 cm

Item 4300-175



Discharge stand steel tripod
bottom height rubber pot 360 mm,
stand space 70x80x80 cm

Item	type
4300-160	2 1/2" AG without coupling
4300-170	3" AG without coupling
4300-250	MT KK70 2 1/2" IG
4300-252	MT KK89 3" IG
4300-255	Adapter KK89
4300-260	Adapter KK70
4300-270	Adapter MK50
4300-280	MT MK50
4300-290	MT MK65

Discharge stand steel skid
bottom height rubber pot 360 mm,
stand space 70x80x81 cm

Item	type
4300-180	2 1/2" AG without coupling
4300-190	3" AG without coupling
4300-200	MT KK70 2 1/2" IG
4300-201	MT KK70 3" IG
4300-202	MT KK89 3" IG
4300-205	Adapter KK89
4300-210	Adapter KK70
4300-220	Adapter MK50
4300-230	MT MK50
4300-240	MT MK65



SET retaining pin, chain and splint for discharge stands steel MK50/KK70

Item 4300-519



Adapter for discharge stands steel KK89 with retaining pin
system Putzmeister

Item 4300-525



Discharge stand steel tripod, italian version
rotatable 3" AG
with Camlock MT 2 1/2" IG,
galvanised, type B-250 steel

Item 4300-145



Adapter for discharge stands steel MK50
system Putzmeister

Item type

4300-520	without retaining pin
4300-521	with retaining pin



Discharge stand steel tripod, swiss version
with a small hose box,
bottom height rubber pot 500 mm,
galvanised, stand space 70x84x84 cm

Item 4300-150



Swivel part for discharge stand steel tripod, italian version
with adapter and Camlock

Item 4300-600



Adapter for discharge stands steel KK70
system Putzmeister

Item type

4300-522	without retaining pin
4300-523	with retaining pin



Hose box 50 small swiss version
for discharge stands 4300-150

Item 4300-153



Coupling Camlock 2 1/2" AG
MT B-250-316, DN65, steel,
PN16

Item 3292-251



Air and water hoses

Rubber air and water hose black, with claw coupling made of brass pressure 10 bar, complete assembled



Item	dimension	bundle
3306-105	3/8"	5 m
3306-110	3/8"	10 m
3306-120	3/8"	20 m
3306-205	1/2"	5 m
3306-210	1/2"	10 m
3306-211	1/2"	11 m
3306-213	1/2"	13,3 m
3306-215	1/2"	15 m
3306-220	1/2"	20 m
3306-320	3/4"	20 m
3306-340	3/4"	40 m

Rubber air and water hose black pressure 10 bar, temperature -30°C to +70°C



Item	dimension	bundle
3301-010	3/8"	50 m
3301-013	1/2"	40 m
3301-019	3/4"	40 m
3301-020	3/4"	100 m

PVC air and water hose red, with brass claw coupling pressure 7 bar, complete assembled

Item	dimension	bundle
3305-205	1/2"	5 m
3305-210	1/2"	10 m
3305-211	1/2"	11 m
3305-213	1/2"	13,3 m
3305-215	1/2"	15 m
3305-216	1/2"	16,6 m
3305-220	1/2"	20 m
3305-325	3/4"	25 m
3305-350	3/4"	50 m

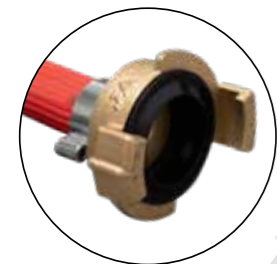

PVC air and water hose red pressure 7 bar

Item	dimension	bundle
3300-013	1/2"	50 m
3300-015	1/2"	100 m
3300-020	3/4"	25 m
3300-019	3/4"	50 m



Air and water hose ULTRALIGHT and clamps

Rubber air and water hose 19 mm ULTRALIGHT with brass claw coupling pressure 40 bar, up to 70 % less weight compared to conventional rubber air and water hose, dimension 3/4", complete assembled

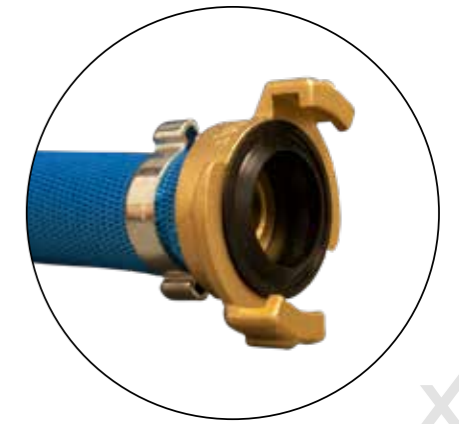

Item	bundle
3307-320	20 m
3307-340	40 m

Rubber air and water hose ULTRALIGHT 19 mm pressure 40 bar, up to 70 % less weight compared to conventional rubber air and water hose, dimension 3/4", weight 0,18 kg/m



60 m per bundle

Item 3303-019

Hose clamps W1 galvanised

100 pcs in a box

Item	for hose	clamping range
3310-010	3/8"	10-16 mm
3310-012	1/2"	12-20 mm
3310-020	3/4"	20-32 mm
3310-025	1"	25-40 mm
3310-035	1 1/2"	32-50 mm

50 pcs in a box

3310-040	1 3/4"	40-60 mm
3310-050	2"	50-70 mm



Hose clamps W1 galvanised

100 pcs in a box

Item	for hose	clamping range
3311-009	1/4" 3/8"	13-15 mm
3311-010	3/8"	15-18 mm
3311-012	1/2"	19-22 mm
3311-020	3/4"	23-27 mm



Claw couplings



Water spray guns and GEKA plus claw couplings

Claw coupling brass

20 pcs in a bag

with nozzle

Item	dimension
3350-001	3/8"
3350-002	1/2"
3350-003	3/4"
3350-004	1"

with rotatable nozzle

3350-006	3/4"
3350-007	1"



Claw coupling brass with inner thread

20 pcs in a bag

Item	dimension
3351-001	3/8"
3351-002	1/2"
3351-003	3/4"
3351-004	1"
3351-005	1 1/4"
3351-006	1 1/2"



Claw coupling brass with outer thread

20 pcs in a bag

Item	dimension
3352-001	3/8"
3352-002	1/2"
3352-003	3/4"
3352-004	1"
3352-005	1 1/4"



Claw coupling brass fixable, with nozzle, fixing to prevent an autonomous screw off

10 pcs in a bag

Item	dimension
3354-002	1/2"
3354-003	3/4"
3354-004	1"



Claw coupling brass with 1" inner thread, ROTATABLE 360°

20 pcs in a bag

Item 3355-004



Spray nozzle brass with claw coupling

10 pcs in a bag

Item	dimension
3353-001	1/2"
3353-002	3/4"



Claw coupling brass blind piece

20 pcs in a bag

Item 3353-009



Y water distributor with 3 claw couplings, dimension 3/4"

10 pcs in a bag

Item 3353-005



Sealing for claw coupling

100 pcs in a bag

Item 3350-000



Water spray gun PRO with 3/4" IG and plug connection

Item 3353-003



Water spray gun PRO with 3/4" IG and claw coupling

Item 3353-004



GEKA plus claw coupling with nozzle and 300C NBR ring, 40 bar pressure

10 pcs in a bag

Item dimension

3360-001	3/8"
3360-002	1/2"
3360-003	3/4"
3360-004	1"



GEKA plus claw coupling with inner thread and 300C NBR ring, 40 bar pressure

10 pcs in a bag

Item dimension

3361-002	1/2"
3361-003	3/4"
3361-004	1"



GEKA plus claw coupling with 1" inner thread, rotatable, with 300C NBR ring, 40 bar pressure

10 pcs in a bag

Item 3365-004



GEKA plus claw coupling with nozzle rotatable and 300C NBR ring, 40 bar pressure

10 pcs in a bag

Item dimension

3366-003	3/4"
3366-004	1"



GEKA plus claw coupling with nozzle fixable and 220C NBR ring, 50 bar pressure

5 pcs in a bag

Item dimension

3364-003	3/4"
3364-004	1"



GEKA plus claw coupling with outer thread and 300C NBR ring, 40 bar pressure

10 pcs in a bag

Item dimension

3362-001	3/8"
3362-002	1/2"
3362-003	3/4"
3362-004	1"



GEKA plus replacement sealing black 300C NB

100 pcs in a bag

Item 3360-000





Battery power trowel
Page 106-107



Hand lever grease gun
Page 115

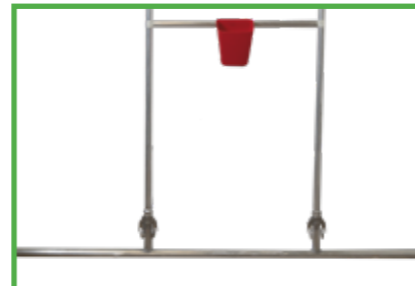

Liquid screed bar FIX
Page 117



Smoothing spatula SET
Page 133



Power grinder
Page 136-137



Vacuum cleaner
Page 138



Plaster finishing machine
Page 139-141



Plaster plane SHARK
Page 146



Insulation knife
Page 150



Battery power scissors
Page 151



Bevelling shears ECO
Page 151



Insulation cutter
Page 161

Tools and devices

100-161

For screed layers and concreters

Screed smoothing machines	102
Smoothing discs and accessories	104
Power trowels and accessories	106
Screeding levels and spirit levels	108
Screeding tools	112
Liquid screed bars	116
Screed laying pants	119
Smoothing shoes and knee pads	120
Gloves	121

For plasterer, drywaller and painter

Wooden ladders, trestles and accessories	122
T-profiles and h-profiles	126
Types of tothing	127
Smoothing trowels	128
Plaster spatulas	130
Trowels and corner trowels	131
Spatulas and accessories	132
Power grinder and Plaster finishing machine	136
Sponge floats and replacement pads	142
Coating roller and painting tools	145
Plaster planes	146
Grinding floats and grinding tools	148
Drywall tools	149

General construction tools and devices

Knives and saws	150
Shears	151
Floor scrapers	152
Tacker and staples	152
Mixer, mortar troughs and buckets	153
Foam guns	154
Construction tools	154
LED floodlights	157
Styrofoam cutter and accessories	158
Insulation cutter	161

All products labelled with X are from our own production or are produced exclusively for us according to our specifications.

**NO MORE ANNOYING CABLE WINDING AND UNWINDING
AND NO MORE DANGEROUS TRIPPING HAZARDS.**

 With a battery runtime of up to **110 min**, around **300 m²** of screed can be smoothed.

 The Battery powered smoothing machine weights only 37 kg (without batteries and disc), both batteries total weight 7,3 kg.

 The machine is operated with 2 pcs 56 volt, 12 Ah batteries. The charging time of a battery is only 80 minutes.

 The soft start of the motor protects the user and makes starting much more comfortable.

 Smoothing discs in various designs and dimensions can be easily attached by flange connection.

 **TWO SPEEDS**
130 and 155 rpm

 **BATTERY LEVEL INDICATOR**
The charge level is permanently displayed and is also visible at all times during work



Battery screed smoothing machine

Battery screed smoothing machine

without batteries, without disc,
Included in delivery:
LED-spotlight, trowel, bluetooth speaker, water bottle

Item	Mounting
5010-000	4-hole
5012-000	FRÜH (bayonet)



Battery Set
2 batteries, 1 single-charger,
1 transport case

Item 5020-000



Battery 12 Ah
56 volt, 672 Wh,
weight 3,9 kg

Item 5020-120



Fast charger
56 volt

Item 5020-020



Transport case
for 5 batteries, or
2 batteries+charger

Item 5020-010



6-fach Multiport Charging case 56 V
charge 6 EGO batteries in approx 3,5 h

Item 5020-030

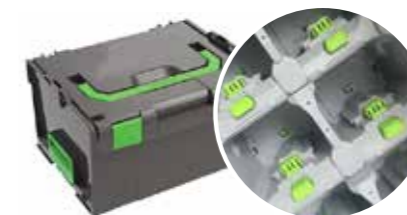

scan & watch the video



Suitable, as well as others, for our battery screed smoothing machine:

Smoothing disc pressed 60 cm, edge 45°

suitable for XS 600, Brinkmann, Kreber, Clipper and Innova 3000, bolt circle 13 cm

Item thickness

5040-601	3 mm
5040-602	3,5 mm
5040-604	4 mm



Smoothing disc pressed 73,5 cm, edge 90°

suitable for XS 600, Brinkmann, Kreber, Clipper and Innova 3000, thickness 3 mm bolt circle 13 cm

Item 5040-703



Smoothing disc pressed with adapter

diameter 56 cm, edge small 45°, thickness 4 mm, weight 8,9 kg, bolt circle 13 cm

Item 5040-560



Smoothing disc turned with Aluminium support disc
edge with faze, thickness 5,6 mm, bolt circle 13 cm

Item weight diameter

5040-600	20,6 kg	60 cm
5040-700	24,8 kg	70 cm



Aluminium support disc
bolt circle 13/41 cm, weight 7,9 kg

Item 4490-601



Grinding ring WK 16 with support plate
44 cm, weight 9,4 kg, bolt circle 13 cm

Item 5040-440



Grinding ring WK 16
44 cm

Item 2293-440



Smoothing disc turned 60 cm

bolt circle 41 cm, suitable for XL 600, XB 600, Glättmeister, SAG and ABG

Item 5041-600



Smoothing disc turned 70 cm

bolt circle 41 cm, suitable for XL 700 and ABG

Item 5041-700



Smoothing disc turned 70 cm

bolt circle 58 cm, suitable for Glättmeister and SAG

Item 5041-701



Smoothing disc pressed 60 cm, with high edge

bolt circle 41 cm, suitable for XL 600, GM 6, and EM 6

Item 5041-603



Smoothing disc 60 cm with bayonet

suitable for FRÜH

Item 5041-606



Smoothing disc 60 cm 6 bolts without adapter

suitable for FRÜH

Item 5040-606



Smoothing disc pressed, with small edge

with 3 screws M 10, bolt circle 24 cm, suitable for Silekto

Item diameter

5041-560	56 cm
5041-607	60 cm



Battery-powered trowel



Smoothing blades



Battery-powered trowel
without batteries, without trowel attachment,
with bayonet lock,
infinitely variable speed, soft start

Item 5016-000

Batteries and accessories can be found on page 103.

Trowel attachment 850 mm
with bayonet lock, clockwise,
weight 33,2 kg

Item 5045-850



Smoothing disc 735 mm
with bayonet lock, clockwise,
weight 16,5 kg

Item 5047-735

Item 5047-735 Replacement disc



Edge smoothing attachment 608 mm
with bayonet lock, clockwise,
weight 21,4 kg

Item 5045-608



Smoothing disc 980 mm
universal, with carrier,
weight 18,5 kg

Item 5050-980



Fine smoothing blades 850 mm
for power trowel,
suitable for 5045-850

4 pcs

Item 5046-850



Fine smoothing blades 600 mm
for edge smoother, suitable for
5045-608 und Moskito

4 pcs

Item 5046-608



Fine smoothing blades 750 mm
suitable for
Moskito 750 edge smoother

4 pcs

Item 5050-750



Fine smoothing blades 14"
suitable for
Besto/Kreber B436 900 mm

4 pcs

Item 5050-200



Fine smoothing blades 18"
suitable for
Besto B446 1.200 mm

4 pcs

Item 5050-201



Combination sash 14"
suitable for
Besto/Kreber B463 900 mm

4 pcs

Item 5050-120



Fine smoothing blades 600 mm
suitable for
Schwammborn 525800

4 pcs

Item 5050-608



Fine smoothing blades 830 mm
suitable for
Schwammborn 795305

4 pcs

Item 5050-830



Smoothing disc 60 cm
with carrier

4 pcs

Item type

5050-302 universal
5050-304 for Barikell



Straight finish of the aluminium and the bubble!

Bubble:

- 1 extra big bubble
- 2 steel rings
- green colored edges with a sharp contour for 2% gradient
- fluorescent

A very high reading exactness and speed was one of the most important criteria for our Screeding Level. We succeeded in developing a bubble, with which we meet all these demands.

Two steel rings allow the user to look exactly at the bubble. The ends of bubble reflect the green color of the edges, due to this, reading errors can be avoided.

Long-life profile:

Due to the newly developed shape of the profile, the lifetime is extended by 2.5 times, without increasing the weight of the Screeding Level.

The end caps have an equal distance to the edge, so there is no additional material left when pulling off the screed.



SCREEDING LEVEL

LONG-LIFE PROFILE



2% gradient

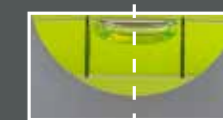

≤ 0,5 mm/m

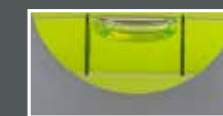

Guarantee
30 years
for the bubble



Acryl

fluorescent

MADE IN AUSTRIA

Screeding level 80x18 mm with 1 bubble fluorescent bubble

Item	length	weight
2510-100	100 cm	0,76 kg
2510-150	150 cm	1,12 kg
2510-200	200 cm	1,48 kg
2510-250	250 cm	1,84 kg
2510-300	300 cm	2,20 kg



Screeding level 100x18 mm with 1 bubble fluorescent bubble

Item	length	weight
2515-100	100 cm	0,88 kg
2515-150	150 cm	1,28 kg
2515-200	200 cm	1,70 kg
2515-250	250 cm	2,14 kg
2515-300	300 cm	2,59 kg





Screeding level 80x18 mm with 2 bubbles

fluorescent bubbles, without handles

Item	length	weight
2511-150	150 cm	1,13 kg
2511-200	200 cm	1,49 kg
2511-250	250 cm	1,85 kg



Screeding level 100x18 mm with 2 bubbles

fluorescent bubbles, without handles

Item	length	weight
2512-100	100 cm	0,91 kg
2512-150	150 cm	1,33 kg
2512-200	200 cm	1,76 kg
2512-250	250 cm	2,17 kg
2512-300	300 cm	2,61 kg



Screeding level 80x18 mm, without bubble

made of aluminium, approx. 720 g/m, with long-life profile and end caps

10 pcs in a box

Item	length
2520-100	100 cm
2520-150	150 cm
2520-200	200 cm
2520-250	250 cm
2520-300	300 cm



Screeding level 100x18 mm, without bubble

made of aluminium, approx. 830 g/m, with long-life profile and end caps

10 pcs in a box

Item	length
2519-100	100 cm
2519-150	150 cm
2519-200	200 cm
2519-250	250 cm
2519-300	300 cm



Screeding level 85x27 mm, swiss version

made of aluminium, without bubble, approx. 900 g/m, with long-life corner and wooden end caps, 1,5 mm thickness

packaging unit 10 pcs

Item	length
2516-100	100 cm
2516-150	150 cm
2516-200	200 cm
2516-250	250 cm
2516-300	300 cm



Spirit level red

Measuring accuracy 0,5 mm/1m, fluorescent zoom-bubble „Made in Austria“, 2K-end caps with anti-shock-function

5 pcs in a box

Item	length
2525-040	40 cm
2525-060	60 cm
2525-080	80 cm
2525-100	100 cm
2525-120	120 cm
2525-150	150 cm
2525-200	200 cm



Cutter for edge insulation strips

ensures millimeter precise and exact cutting of insulation strips, 2 blades 18 mm included

Item 2700-010

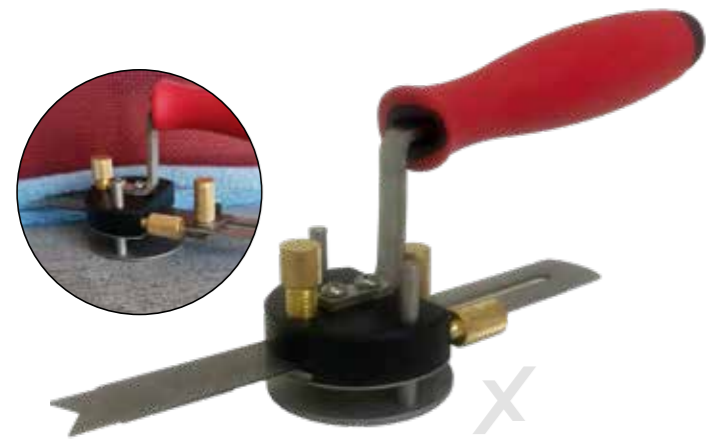

- 2K-handle
- weight 215 g
- height continuously adjustable from 6 to 30 mm
- sliding carriage 50 mm
- double blade for the cutting in both directions
- cutter extendable up to 50 mm

Cutter for edge insulation strips with handle adapter without handle, with 2 blades

Item 2700-013



Cutter for edge insulation strips with wooden handle 130 cm with 2 blades

Item 2700-012



Cutter for edge insulation strips with aluminium telescopic handle 110-200 cm, with 2 blades

Item 2700-011



Sliding carriage for cutter for edge insulation strips

Item 2700-017



Screed gauge made of steel 115 cm with 2K-handle, lasered scale 99-115 cm, weight approx. 2,9 kg

Item 2720-002



Foot XXL

for screed gauge made of aluminium, width 6 cm

Item 2720-001



Tip

for screed gauge made of aluminium

Item 2720-003



Handle

for screed gauge made of aluminium

Item 2720-004



Case

for screed gauge made of aluminium length 865 mm, width 300 mm, height 124 mm

Item 2730-989



Screed gauge made of aluminium

continuously adjustable from 85 to 115 cm, robust, easy to clean, packed in a single box

Item	width foot	weight
2720-000	3 cm	ca 1,2 kg
2720-009	6 cm	ca 2,0 kg



Nailed shoes with strap closure

solvent resistant, with 13 nails, to walk on fresh coatings, nail height 35 mm

10 pair in a box

Item 2705-035



Floorscraper ALU
adjustable height, width 56 cm, handle holder metal 28 mm

Item 2709-560



Floorscraper ALU with wooden handle
adjustable height, width 56 cm, length handle 130 cm, handle holder Vario

Item 2709-561

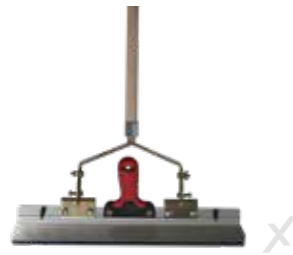

Floorscraper steel
adjustable height, width 80 cm, handle holder metal 28 mm

Item 2709-800

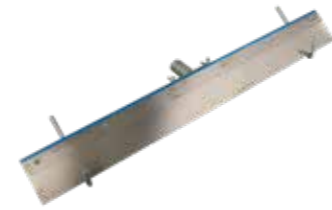

Floorscraper steel with wooden handle
adjustable height, width 80 cm, length handle 130 cm, handle holder Vario

Item 2709-801



De-aerating roller
double sided bracket and splash protection

Item	spikes	length
2706-251	11 mm	250 mm
2706-253	31 mm	250 mm
2706-501	11 mm	500 mm
2706-503	31 mm	500 mm



Flooring trowel, wooden handle
reinforced version, blade thickness 1 mm

20 pcs in a box

Item	dimension
2710-400	400x90 mm
2710-500	500x90 mm
2710-600	600x90 mm
2710-700	700x90 mm
2710-800	800x90 mm
2711-500	500x110 mm



Flooring trowel, 2K-handle
reinforced version, blade thickness 1 mm

20 pcs in a box

Item	dimension
2712-400	400x90 mm
2712-500	500x90 mm
2712-600	600x90 mm
2712-700	700x90 mm



Concret flooring trowel BOSS, 2K-handle

american style, round type, 10-times welded, dimension 475x120 mm

10 pcs in a box

Item 2718-475



Expansion joint trowel for screed
aluminium cast 120x280 mm, front bent, joint 5x22 mm

Item 2700-000



Screed levelling tripod
for the height determination during work with floating screed, sprint clamping

Item 2720-099



Screed levelling tripod with spindle, version Putzmeister
for the height determination during work with floating screed, Operating range ca. 20- 140 mm, with screw adustment

Item 2720-098



Multi-purpose grease

12 pcs in a box

Item 2740-400



Hand lever grease gun
with hose and mouthpiece, for 400 g cartridge

Item 2740-401



Liquid screed bar VARIO



A liquid screed bar is used daily by liquid screed layers. Therefore it should be practical and flexible in handling and especially in transport.

We have now the optimal solution. With our Liquid screed bar VARIO you need only 1 Liquid screed bar which can be individually adapted and you save costs for the purchase of different lengths.

The tube is screwable and can be extended in steps of 40cm. The length can be varied from 80 cm to 320 cm depending on the construction site conditions.



The handle bars are fastened by means of a quick-release fastener.

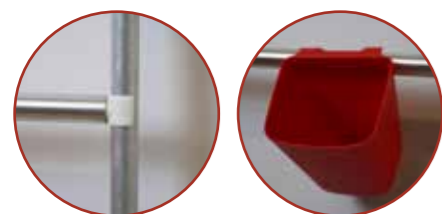

The clip-in crossbar can be adjusted in height and serves as a holder for the supplied waste container.

Scope of delivery for each liquid screed bar (depending on length):
Base body, handle, end caps, threaded tube 20/40 cm, cross bar, waste container, wrench

Liquid screed bar VARIO

Liquid screed bar VARIO handles 45°
with 2 handles

Item	length
2730-085	0,8 m
2730-125	1,2 m
2730-165	1,6 m
2730-205	2,0 m
2730-245	2,4 m
2730-285	2,8 m
2730-325	3,2 m

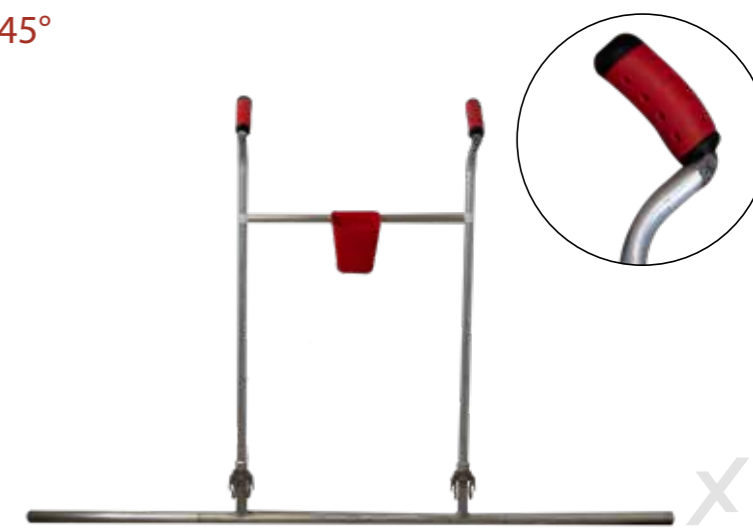

Liquid screed bar VARIO handles 90°
with 2 handles

Item	length
2730-085	0,8 m
2730-120	1,2 m
2730-160	1,6 m
2730-200	2,0 m
2730-240	2,4 m
2730-280	2,8 m
2730-320	3,2 m

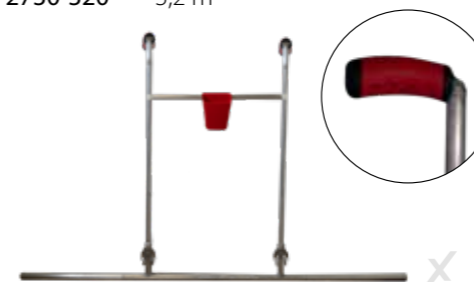

Liquid screed bar VARIO handle 45°
with 1 handle, length 0,8 m

Item 2730-081

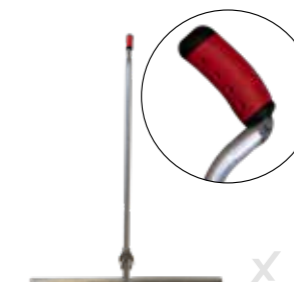

Liquid screed bar VARIO handle 90°
with 1 handle, length 0,8 m

Item 2730-080

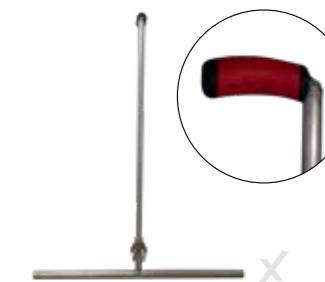

Liquid screed bar FIX handles 45°

Basic body not screwed, with 2 handles, lighter version

Item	length	handles
2720-200	2,0 m	90°
2720-201	2,0 m	45°
2720-250	2,5 m	90°
2720-251	2,5 m	45°



Single parts for liquid screed bar



Screed laying pants

Base body 80 cm
for 1 handle

Item 2730-981



Base body 80 cm
for 2 handles

Item	length	type
2730-982	80 cm	VARIO
2730-984	200 cm	FIX
2730-986	250 cm	FIX



Handle bar 90°
with coupling
and 2K-handle

Item 2730-960



Handle bar 45°
with coupling
and 2K-handle

Item 2730-961



Extension piece
with thread

Item	length
2730-920	0,2 m
2730-940	0,4 m



End cap with AG
2 cm

Item 2730-900



Coupling MT IG
with 2 secured
handles

Item 2730-988



Key
steel

Item 2730-945



Cross brace
with pipe clamps

Item 2730-950



Waste container
to hang in

Item 2730-957



Case for Liquid screed bar
weight 3,3 kg

Item 2730-990



Suspenders for screed layer BISON

manufactured according to DIN EN 14404, replaceable knee pads, with velcro closure, strong version, in a single box

Item 2695-000

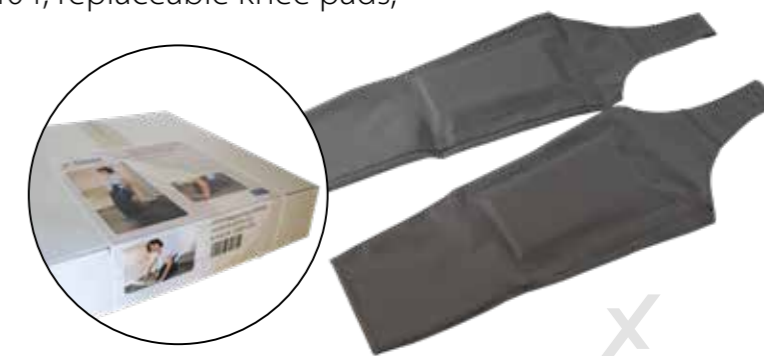

Trousers for screed layer BISON

manufactured according to DIN EN 14404, replaceable knee pads, imitation leather, in a single box

Item	dimension
2695-048	48
2695-050	50
2695-052	52
2695-054	54
2695-056	56
2695-058	58



Dungarees for screed layer BISON

manufactured according to DIN EN 14404, replaceable knee pads, with elasticated band, imitation leather, in a single box

Item	dimension
2696-048	48
2696-050	50
2696-052	52
2696-054	54
2696-056	56
2696-058	58



Suspenders for screed layers FLEX
tested according to DIN EN 14404, replaceable knee pads, with press buttons, light version

Item 2690-001



Trousers for screed layer HERO

tested according to DIN EN 14404, replaceable knee pads, imitation leather

Item	dimension
2690-048	48
2690-050	50
2690-052	52
2690-054	54
2690-056	56
2690-058	58

Dungarees for screed layer HERO

tested according to DIN EN 14404, replaceable knee pads, imitation leather

Item	dimension
2691-048	48
2691-050	50
2691-052	52
2691-054	54
2691-056	56
2691-058	58

Suspenders for screed layers HERO
tested according to DIN EN 14404, replaceable knee pads, with velcro closure, strong version

Item 2690-000



Smoothing shoes PVC

grey, with elastic strap,
465x215 mm, 2,06 kg/pair

40 pairs in a box

Item 2700-077



Smoothing shoes PVC

blue, made from new granulate,
with fastening spring,
395x200 mm, 1,08 kg/pair

50 pair in a box

Item 2700-076



Smoothing shoes PVC

black, with fastening spring,
395x200 mm, 1,08 kg/pair

50 pair in a box

Item 2700-074



Fastening spring

for smoothing shoes PVC

Item 2700-075



Smoothing shoes PVC

light version, with cap,
grey, with elastic strap,
410x230 mm, 1,38 kg/pair

10 pair in a box

Item 2700-078



Elastic strap

for smoothing shoes PVC grey

Item 2700-079



Knee pads

shell shape

Item 2700-001



Nitril knobs

very good sense of touch,
breathable, dimension 10

120 pair in a box

Item 653-110



Black grip

very good sense of touch,
polyester, breathable

120 pair in a box

Item dimension

2655-009 9

2655-010 10



Nitril gold

very flexibel,
fully coated finger

144 pair in a box

Item dimension

2650-009 9

2650-010 10

2650-011 11



Neoprene

with softly cotton material,
extra long shaft

144 pair in a box

Item dimension

2653-010 10

2653-011 11



Wooden ladders

ERGOTRITT plug-on step

Our wooden ladders and folding trestles originate from sustainable forestry.

We are committed to environmentally friendly and social management of forests, this ensures their use for present and future generations.

By purchasing our products, you decide to use our forest resources sustainably.

Wooden ladder AT

3. rung made of hard wood
tested according to ÖNORM EN 131,
load capacity 150 kg,
FSC-certified

Item	rungs	length
2750-004	4	1,36 m
2750-005	5	1,66 m
2750-006	6	1,96 m
2750-007	7	2,26 m
2750-008	8	2,56 m
2750-009	9	2,86 m
2750-010	10	3,15 m
2750-011	11	3,45 m
2750-012	12	3,75 m



Wooden ladder AT-S with metal bars

3. rung made of hard wood
tested according to ÖNORM EN 131,
load capacity 150 kg,
made from FSC-certified wood

Item	rungs	length	metal bars
2754-004	4	1,36 m	1
2754-005	5	1,66 m	2
2754-006	6	1,96 m	2
2754-007	7	2,26 m	2
2754-008	8	2,56 m	2
2754-009	9	2,86 m	3
2754-010	10	3,15 m	3
2754-012	12	3,75 m	3
2754-014	14	4,35 m	4

Folding step ERGO

4-step,
width 42 cm, Height 93 cm,
load capacity 150 kg,
FSC-certified

Item 2755-103



ERGOTRITT plug-on step made of aluminium

width 90 mm, height 360 mm

2 pcs in a box

Item	for rungwidth
2750-360	24-26 mm
2754-360	21-23 mm



Advantages:

- very easy to attach - holds perfectly
- the rung becomes a step
- ensures a safe and comfortable stand on the ladder
- protects the ankle joints from overloading
- Reduced risk of accidents
- Robust aluminium



Rubber foot for ladder

for ladders and wooden trestles

Item	stringer	for
2750-105	60x22 mm	3-8 rungs
2750-106	68x22 mm	9-12 rungs

4 pcs in a box

2750-107	60x22 mm	3-8 rungs
2750-109	68x22 mm	9-12 rungs



Hinge clamp for ladder extension

universal, tension depth 60 mm, tension width 60-85 mm

Item 2750-103

Item 2750-113 4 pcs im box



Extension ladder stringer 120 cm for wooden ladder

without clamp, FSC-certified

1 pair

Item	dimension	suitable
2750-102	60x22 mm	3-8 rungs
2750-104	68x22 mm	9-12 rungs



Bag for ladders

closed all round, with velcro easy fixing on the ladder, measures: 25x9 cm

Item 2750-110

Item 2750-111 packed in a single box



Extension for wooden ladder

FSC-certified

1 pair

Item	dimension	suitable	type
2750-100	60x22 mm	3-8 rungs	4 clamps
2750-098	60x22 mm	3-8 rungs	2 clamps/2 bars
2750-099	68x22 mm	9-12 rungs	4 clamps



Wooden trestle small with centre stand No. 1

without pins, width 80 cm, height 80 cm, FSC-certified

packaging unit 1 pair

Item 2752-001



Wooden trestle with 2 rungs

very robust construction, load capacity 150 kg, width 60 cm, height 80 cm, FSC-certified

Item 2752-010



Wooden trestle with slope support No. 2

width 60 cm, height 80 cm, FSC-certified

packaging unit 1 pair

Item 2752-002



Steel pin

7x210 mm, for woodentrest No. 1 and No 3

Item 2752-010



Wooden trestle big with centre stand No. 3

without pins, width 64 cm, height 138 cm, FSC-certified

packaging unit 1 pair

Item 2752-003



h-profiles and T-profiles



h-profile light version

113x28 mm, approx 840 g/m,
thickness 1,7 mm,
with reinforced bulge

packaging unit 10 pcs

Item	length
2500-100	100 cm
2500-120	120 cm
2500-150	150 cm
2500-180	180 cm
2500-200	200 cm
2500-220	220 cm
2500-250	250 cm
2500-300	300 cm

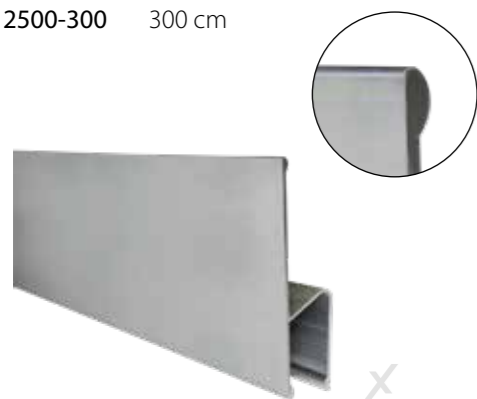

h-profile with tothing 10x10 mm

113x28 mm, approx 780 g/m,
thickness 1,5 mm,
length 120 cm

packaging unit 10 pcs

Item 2504-120

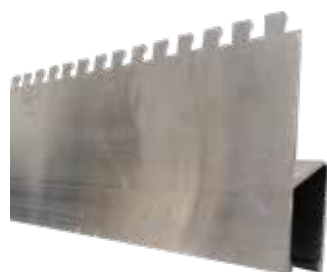

h-profile strong version

115x29 mm, approx 970 g/m,
thickness 2,2 mm,
without bulge

packaging unit 10 pcs

Item	length
2501-100	100 cm
2501-120	120 cm
2501-150	150 cm
2501-180	180 cm
2501-200	200 cm
2501-220	220 cm
2501-250	250 cm
2501-300	300 cm

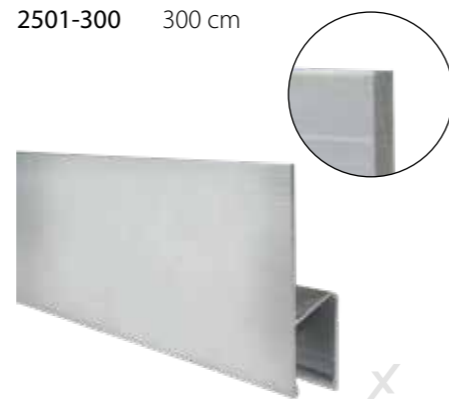

T-profile reinforced type

98x17 mm, approx 680 g/m,
thickness 1,2 mm

packaging unit 10 pcs

Item	length
2502-100	100 cm
2502-120	120 cm
2502-150	150 cm
2502-180	180 cm
2502-200	200 cm
2502-220	220 cm
2502-250	250 cm



types of tothing

E3 - 3 x 3 x 3 mm



E4 - 4 x 4 x 4 mm



E6 - 6 x 6 x 6 mm

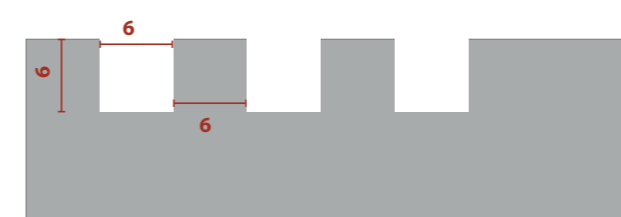

E8 - 8 x 8 x 8 mm

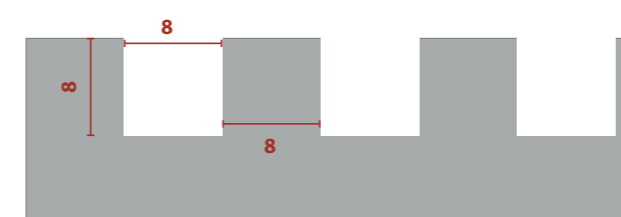

E10 - 10 x 10 x 10 mm

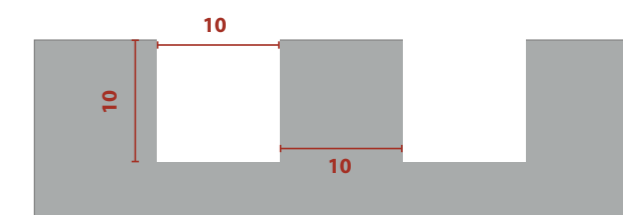

E11 - 10 x 10 x 15 mm

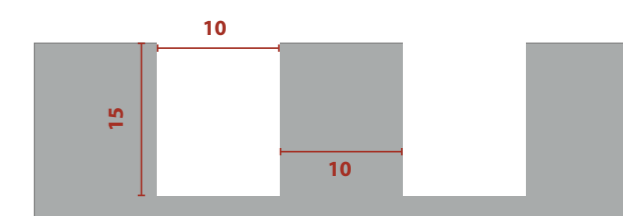

E12 - 12 x 12 x 12 mm

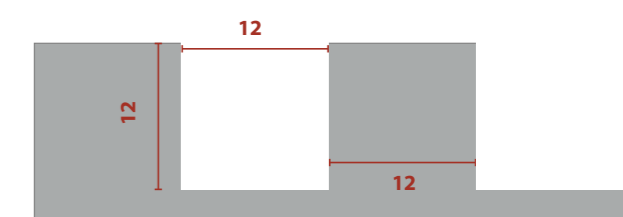

E16 - 6 x 6 x 10 mm

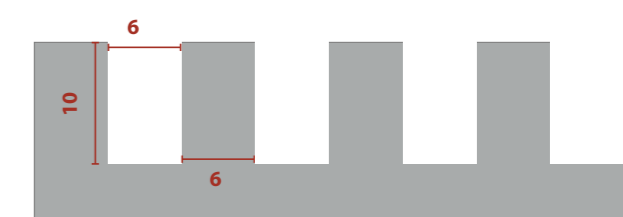

Smoothing trowels



Smoothing trowel 280x130 mm stainless, 2K-handle
blade thickness 0,7 mm, 4-times fastened

10 pcs in a box

Item 2102-280



Smoothing trowel PVC PREMIUM 280x130 mm, orange handle

10 pcs in a box

Item	blade thickness
2101-281	3 mm
2101-283	2 mm



Smoothing trowel PVC 280x130 mm, 2K-handle
blade thickness 3 mm

10 pcs in a box

Item 2101-285



Smoothing trowel PVC 280x130 mm, black handle
blade thickness 3 mm

10 pcs in a box

Item 2101-280



Smoothing trowel 280x130 mm, wooden handle
blade thickness 0,7 mm, 4-times fastened

10 pcs in a box

Item	type
2100-280	stainless
2105-280	steel



Smoothing trowel BOSS GOLD, 300x120 cm, leather-handle
blade thickness 0,7 mm, stainless, polished, american style

10 pcs in a box

Item 2103-600



Smoothing trowel BOSS, cork-handle
blade thickness 0,7 mm, stainless, polished, american style

10 pcs in a box

Item	dimension
2103-300	300x120 mm
2103-360	360x120 mm



Smoothing trowel 280x130 mm, wooden handle
blade thickness 0,7 mm, with tothing, 4-times fastened

10 pcs in a box

stainless

Item	tothing
2100-284	E4
2100-286	E6
2100-288	E8
2100-290	E10
2100-291	E11
2100-292	E12

steel

Item	tothing
2105-283	E3
2105-284	E4
2105-286	E6
2105-288	E8
2105-290	E10
2105-291	E11
2105-292	E12



Smoothing trowel 280x130 mm stainless, 2K-handle
blade thickness 0,7 mm, with tothing E10, 4-times fastened

10 pcs in a box

Item 2102-290



Smoothing trowel 400x130 mm, wooden handle
blade thickness 0,7 mm, with tothing, 4-times fastened

10 pcs in a box

stainless

Item	tothing
2100-406	E6
2100-408	E8
2100-410	E10

steel

Item	tothing
2105-406	E6
2105-408	E8
2105-410	E10



Smoothing trowel 400x130 mm stainless, wooden handle
blade thickness 0,7 mm, 4-times fastened

10 pcs in a box

Item 2100-400



Smoothing trowel 480x130 mm, wooden handle
blade thickness 0,7 mm, with tothing, 6-times fastened

10 pcs in a box

stainless

Item	tothing
2100-486	E6
2100-488	E8
2100-490	E10
2100-492	E12

steel

Item	tothing
2105-486	E6
2105-488	E8
2105-490	E10
2105-491	E11
2105-492	E12
2105-496	E16



Smoothing trowel 480x130 mm, wooden handle
blade thickness 0,7 mm, 6-times fastened

10 pcs in a box

Item	type
2100-480	stainless
2105-480	steel



Plaster spatula stainless with G-shaped neck, 2K-handle
thickness 1 mm, polished, completely welded, lifetime guaranty for the welding

30 pcs in a box

Item	width
2123-100	100 mm
2123-120	120 mm



Plaster spatula stainless with G-shaped neck, 2K-handle
5 years guaranty for the welding

30 pcs in a box

Item	width
2124-060	60 mm
2124-080	80 mm
2124-100	100 mm
2124-120	120 mm
2124-140	140 mm



Plaster spatula stainless with G-shaped neck, wooden handle
5 years guaranty for the welding

30 pcs in a box

Item	width
2120-020	20 mm
2120-040	40 mm
2120-060	60 mm
2120-080	80 mm
2120-100	100 mm
2120-120	120 mm



Plaster spatula steel hardened with G-shaped neck, wooden handle
tempered and smoothed, lifetime guaranty for the welding

30 pcs in a box

Item	width
2122-080	80 mm
2122-100	100 mm
2122-120	120 mm



Pointing trowel, wooden handle
5 years guaranty for the welding, length 160 mm

30 pcs in a box

Item 2125-160



Plasterer's pan wooden handle
galvanised, 180 mm

40 pcs in a box

Item 2140-180



Plaster flat blade angular/pointed stainless with plastic-coated handle

Item	width
2145-010	10 mm
2145-020	20 mm
2145-030	30 mm



Brick trowel stainless with G-shaped neck, 2K-handle
5 years guaranty for the welding

30 pcs in a box

Item	length
2135-160	160 mm
2135-180	180 mm



Brick trowel stainless with S-shaped neck, 2K-handle
5 years guaranty for the welding, length 180 mm

30 pcs in a box

Item 2137-180



Berner brick trowel stainless with G-shaped neck, 2K-handle
5 years guaranty for the welding, length 160 mm

30 pcs in a box

Item 2136-160



Brick trowel stainless with G-shaped neck, wooden handle
5 years guaranty for the welding, length 180 mm

30 pcs in a box

Item 2130-180



Brick trowel steel hardened with G-shaped neck, wooden handle
hardened, tempered and smoothed, lifetime guaranty for the welding, length 180 mm

30 pcs in a box

Item 2132-180



Degginger brick trowel with G-shaped neck, wooden handle
square, steel hardened, tempered and smoothed, lifetime guaranty for the welding, length 180 mm

30 pcs in a box

Item 2131-180



Inside corner trowel stainless, wooden handle
5 years guaranty for the welding

30 pcs in a box

Item	length
2111-080	80 mm
2111-120	110 mm



Outside corner trowel stainless, wooden handle
5 years guaranty for the welding

30 pcs in a box

Item	length
2112-080	80 mm
2112-120	110 mm



U-shaped corner trowel stainless, wooden handle
5 years guaranty for the welding, length 80 mm

30 pcs in a box

Item 2110-080



Smoothing spatulas ALU

INNOXAT

Smoothing spatulas PVC and accessoires

Smoothing spatula ALU Q3-Q4

with hardened blade 0,3 mm, rounded corners, red secured end-caps

10 pcs in a box

Item	length
2155-023	25 cm
2155-043	40 cm
2155-063	60 cm
2155-083	80 cm
2155-103	100 cm
2155-123	125 cm
2155-153	150 cm



Smoothing spatula ALU Q3

with hardened blade 0,5 mm, sharp corners, red secured end-caps

10 pcs in a box

Item	length
2155-425	25 cm
2155-445	40 cm
2155-465	60 cm
2155-485	80 cm
2155-505	100 cm
2155-525	125 cm
2155-555	150 cm



Blade stainless 0,5 mm

4x4 mm, ultraflexible, hardened

10 pcs in a box

Item	length
2155-842	25 cm
2155-843	40 cm
2155-844	60 cm
2155-845	80 cm
2155-846	100 cm
2155-847	125 cm
2155-848	150 cm



Smoothing spatula PVC Q3-Q4

with hardened blade 0,3 mm, rounded corners, red secured end-caps

10 pcs in a box

Item	length
2156-023	25 cm
2156-043	40 cm
2156-063	60 cm
2156-083	80 cm
2156-103	100 cm
2156-123	125 cm
2156-153	150 cm

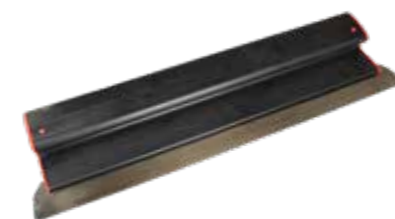

Blade stainless 0,3 mm for PVC Q3-Q4

ultraflexible, hardened, rounded corners

10 pcs in a box

Item	length
2156-223	25 cm
2156-243	40 cm
2156-263	60 cm
2156-283	80 cm
2156-303	100 cm
2156-323	125 cm
2156-353	150 cm



Smoothing spatula PVC SET in a case

1 pcs each smoothing spatula 25 cm, 40 cm, 60 cm, 80 cm, 100 cm, handle adapter and telescopic handle

Item 2156-010



Blade stainless 0,3 mm

ultraflexible, hardened, rounded corners

10 pcs in a box

Item	length
2155-223	25 cm
2155-243	40 cm
2155-263	60 cm
2155-283	80 cm
2155-303	100 cm
2155-323	125 cm
2155-353	150 cm



Blade stainless 0,5 mm

ultraflexible, hardened, sharp corners

10 pcs in a box

Item	length
2155-625	25 cm
2155-645	40 cm
2155-665	60 cm
2155-685	80 cm
2155-705	100 cm
2155-725	125 cm
2155-755	150 cm



Blade stainless 0,5 mm

10x10 mm, ultraflexible, hardened

10 pcs in a box

Item	length
2155-892	25 cm
2155-893	40 cm
2155-894	60 cm
2155-895	80 cm
2155-896	100 cm
2155-897	125 cm
2155-898	150 cm



Handle adapter for smoothing spatula ALU without handle

10 pcs in a box

Item 2155-000



Handle adapter for smoothing spatula PVC without handle

10 pcs in a box

Item 2156-000



Telescopic handle for handle adapter 2155-000

stable aluminium fiber glass extension, suitable also for roller hangers, length 123-220 cm

10 pcs in a box

Item 2155-001



Wall scraper clamp VARIO universal

adjustable,
outside thread M18x1,5
galvanised

10 pcs in a box

Item 2159-000



Wall spatula clamp small

for 24 mm handle,
suitable for wall spatula
(2150, 2151, 2157)

10 pcs in a box

Item 2159-001



Wall spatula completely mounted with wall spatula clamp VARIO, wooden handle 130 cm and wall spatula alu 80 cm

Item 2159-200



Wooden handle with thread

length 130 cm, weight 0,52 kg
thread M18x1,5
28 mm thick version,
suitable for wall scraper
and aluminium sponge float

10 pcs in a box

Item 2320-402



Telescopic handle made of aluminium reinforced with thread

length 110-200 cm,
thread M18x1,5,
suitable for wall spatula
and aluminium sponge float

10 pcs in a box

Item 2320-403



Aluminium handle reinforced with thread

length 180 cm,
thread M18x1,5
suitable for wall spatula
and aluminium sponge float

10 pcs in a box

Item 2320-404



Wooden handle with thread reinforced

length 140 cm, weight 0,85
thread M18x1,5
20/36 mm extra thick version,
suitable for wall scraper
and aluminium sponge float

10 pcs in a box

Item 2320-405



Wall spatula Alu, cork-handle

blade thickness 0,5 mm,
blade friction-locked,
pre-drilled for wall spatula clamp
small (2159-001)

10 pcs in a box

Item	length
2157-500	50 cm
2157-600	60 cm



Wall spatula, wooden handle

black steel riveted,
blade thickness 0,5 mm

10 pcs je box

Item	length
2154-300	30 cm
2154-400	40 cm



Screw handle spatula PREMIUM stainless, 2K-handle

15 cm, with bit, conical polished

12 pcs in a box

Item 2162-150



Wall spatula Alu stainless, 2K-handle

blade thickness 0,5 mm,
blade friction-locked,
pre-drilled for wall spatula clamp
small (2159-001)

10 pcs in a box

Item	length
2151-300	30 cm
2151-400	40 cm
2151-500	50 cm
2151-600	60 cm
2151-800	80 cm



Wall spatula stainless, wood/aluminium, flat plate

blade thickness 0,5 mm,
extra 80 mm wooden plate,
length 80 cm

10 pcs in a box

Item 2152-800



Screw handle spatula stainless, 2K-handle

15 cm, with bit

12 pcs in a box

Item 2161-150



Wall spatula stainless, wooden handle

blade thickness 0,5 mm,
waterproof plywood handle,
pre-drilled for wall spatula
bracket small (2159-001)

10 pcs in a box

Item	length
2150-200	20 cm
2150-300	30 cm
2150-400	40 cm
2150-500	50 cm
2150-600	60 cm



Spatula steel, wooden handle

15 cm

10 pcs in a box

Item 2163-150



Power grinder



Power grinder

230 V, 1.000 W, speed 150 bis 570 rpm
weight of hand-held device without tools 2,4 kg, total 5,7 kg

included:
2 pcs support disc with velcro fastener, 4 pcs of sandpaper K16,
4 pcs of sandpaper K24, carrying strap with carabiner,
carrying case

Item 5150-000

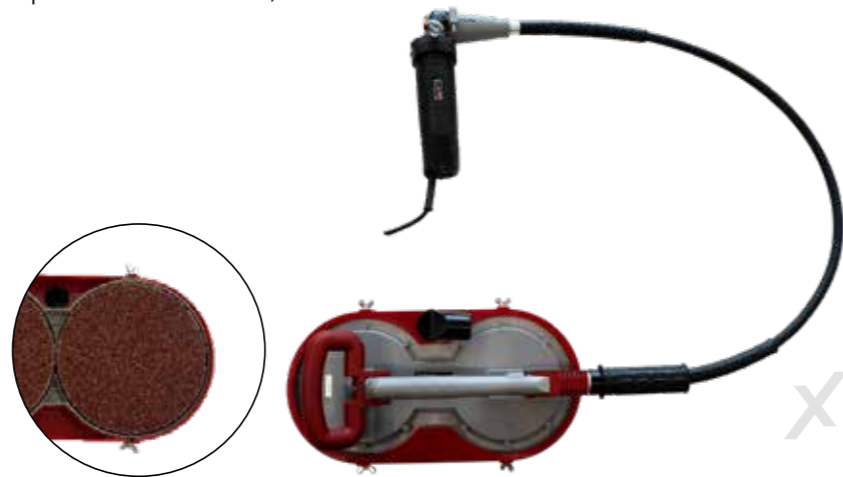

Battery power grinder

230 V, 18 V, 5 Ah, speed 370 rpm
weight of hand-held device without tools 2,4 kg,
with motor 4,7 kg, with battery 5,3 kg

included:
2 pcs 18 Volt 5 Ah batteries (576 g), quick charger,
2 pcs support disc with velcro fastener, 4 pcs of sandpaper K16,
4 pcs of sandpaper K24, carrying strap with carabiner,
carrying case

Item 5160-000



Accessories and spare parts for power grinder

Tool holder*

complete,
without tools

Item 4360-100



Backing pad with velcro*

Item 5190-015

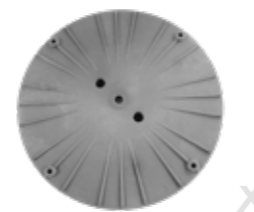

Angular gearbox for power grinder

with drive pinion and brass square
mounted

Item 4360-130



Replacement sandpaper*

200 mm, with velcro
1 pair

Item	Grind
5190-016	K16
5190-024	K24



Motor for power grinder*

with 2 m cable and angular
gearbox

Item 4360-200



Screw*

for tool holder and backing pad

Item 4360-103



Wallpaper remover*

in a case

Item 5190-500



Flexible shaft*

1,3 m

Item 4360-300



Handle for tool holder*

improves handling

Item 5190-060



WK-grinding disc*

1 pcs

Item	Grind
2270-014	K14
2270-024	K24
2270-060	K60



Backpack vacuum cleaner

230 V, 1100 W, weight 6,3 kg,
Vacuum max. 200 mbar, Volume flow max. 28l/s, Dust class L,
with integrated socket for power grinder

included:
Accessory SET 5195-100,
Paper filter bag
Bag with zip fastener

Item 5130-000



Akku-Backpack vacuum cleaner

18 V, 5 Ah, weight 6,1 kg without batteries,
Vacuum max. 38 mbar, Volum flow max 28l/s, Dust class L

included:
2 pcs 18 Volt 5 Ah batteries (576g)
Quick charger
Accessory SET 5195-100
Paper filter bag
Filter bag with zip fastener

Item 5140-000



Paper filter bag 14 liter

Item 4360-500



Paper filter bag 14 liter drainable with zip fastener

Item 4360-510



Lamellar filter

Item 4360-520



Accessory set in a bag weight 4,9 kg

Item 5195-100



Plaster finishing machine

230 V, 1.000 W, Speed 150 bis 570 rpm
weight of hand-held device without tools 3,7 kg, total 5,9 kg

included:
Base disc 350 mm with velcro,
Sponge disc coarse 350 mm with velcro,
Carrying strap with carabiner
Carrying case

Item 5170-000



Battery Plaster finishing machine

230 V, 18 V; 5 Ah, speed 370 rpm,
weight without batteries 3,2 kg, with batteries 3,8 kg

included:
2 pcs 18 Volt 5 Ah batteries (576 g)
Quick charger
Base disc 350 mm with velcro
Sponge disc coarse 350 mm with velcro
Carrying strap with carabiner
Carrying case

Item 5180-000



Spare parts for Plaster finishing machine **INNOXAT**

Motor
with 5 m cable,
weight 2,0 kg

Item 4360-210



Tool holder

Item 4360-110



**Flexible shaft for battery
Plaster finishing machine**
0,5 m

Item 4360-320



**Flexible shaft for
Plaster finishing machine**
2 m

Item 4360-310



Water sprayer

Item 4360-120



**Base plate
with velcro***
350 mm

Item 4360-111



**Velcro for base plate
350 mm***

4 Stück

Item 4360-112



**Rubber disc for
Tool holder***

Item 4360-113



**Repair set for
Tool holder**

Item 4360-132



**Gearbox cap
with shaft**

Item 4360-131



**Plastic gear wheel
135 mm**

Item 4360-117



Grooved ball bearing

Item 4360-116



Carrier plastic

Item 4360-114



Bearing clamping ring

Item 4360-115



Accessories Plaster finishing machine and batteries

**Replacement sponge
with velcro***
18x350 mm

Item 5190-350



**Replacement sponge
with velcro***
30x350 mm, blue

Item 5190-352



**Replacement sponge
with velcro***
30x350 mm, brown

Item 5190-353



Retaining strap with carabiner*
for motor mounting

Item 5190-050



**Carbon brush for
Plaster finishing machine
and grinder**

1 pair

Item 4360-215



**Switch for motor
for Battery plaster finishing
machine and grinder**

Item 4360-240



Battery 18 V, 5 Ah
weight 0,58 kg

Item 5190-005



Quick charger
180 W, weight 0,8 kg

Item 5190-000



**Motor for Battery power grinder
and Plaster finishing machine**
with 2 m cable and angular gearbox

Item 4360-220



Battery adapter for BOSCH

Item 5190-010



Battery adapter for MAKITA

Item 5190-011



Battery adapter for MILWAUKEE

Item 5190-012



All products marked with * are also suitable spare parts for identical models.

Sponge floats



Sponge float 280x140 mm, large-pored 2K-handle

with 18 mm sponge rubber covering, large pored red

10 pcs in a box

Item 2350-280



Sponge float 280x140 mm, fine-pored, 2K-handle
with 18 mm sponge rubber covering, fine pored red

10 pcs in a box

Item 2351-280



Sponge float 280x140 mm, 2K-handle
with 10 mm sponge rubber covering, black

10 pcs in a box

Item 2352-280



Sponge float 280x140 mm, large-pored
with 18 mm sponge rubber covering, large pored red

10 pcs in a box

Item 2300-280



Sponge float 280x140 mm, fine-pored
with 18 mm sponge rubber covering, fine pored red

10 pcs in a box

Item 2301-280



Sponge float 280x140 mm
with 10 mm sponge rubber, black

10 pcs in a box

Item 2302-280



Sponge float ALU, 2K-handle
without sponge rubber

10 pcs in a box

Item	dimension
2310-280	270x130 mm
2310-300	300x200 mm



Sponge float ALU, large-pored, 2K-handle
with 18 mm sponge rubber covering, large pored red

10 pcs in a box

Item	dimension
2311-280	280x140 mm
2311-300	300x200 mm



Sponge float ALU 300x200 mm, 2K-handle
with 30 mm cold foam covering, white

10 pcs in a box

Item 2312-300



Grouting float 250x100 mm, 2K-handle
conical type for epoxy-grouting, red

10 pcs in a box

Item 2359-250



PU float

Item dimension

2305-240	240x110 mm
2305-280	280x140 mm
2305-320	320x180 mm
2305-360	360x200 mm
2305-420	420x220 mm
2305-480	480x240 mm
2305-500	500x280 mm



PU float
1200x120 mm

Item 2305-000



Sponge float ALU 400x200 mm, large-pored, without handle
with 18 mm sponge rubber covering, large pored red, outer thread

10 pcs in a box

Item 2320-400



NOTE: Suitable handles for aluminium handle graters can be found on page 134.

Tools and devices

Tools and devices

Replacements pads and glue

INNOXAT

Replacement sponge large pored
red,
height 18 mm

10 pcs in a box

Item	dimension
2300-281	280x140 mm
2311-301	300x200 mm
2320-401	400x200 mm



Replacement sponge fine pored
red,
dimension 280x140 mm,
height 18 mm

10 pcs in a box

Item 2301-281



Replacement sponge black
sponge rubber,
dimension 280x140 mm,
height 10 mm

10 pcs in a box

Item 2302-281



Replacement cold foam rubber
white,
dimension 300x200 mm,
height 30 mm

10 pcs in a box

Item 2312-301



Contact adhesive 200 g
intended for commercial
use only

6 pcs in a box

Item 2900-220



Coating roller for fillers and painting tools

Coating roller for fillers

without handle, diameter 7,5 cm,
for quick application of ready-to-use
plasters and fillers

10 pcs in a box

Item	length	weight
2440-180	18 cm	0,12 kg
2440-330	23 cm	0,15 kg
2440-300	30 cm	0,18 kg



Apply fillers up to 50% faster than with
conventional tools.

**Roller bracket
for coating roller**

Item	length	weight
2441-180	18 cm	0,23 kg
2441-230	23 cm	0,25 kg
2441-300	30 cm	0,30 kg



Telescopic extension handle steel
length 120-200 cm

10 pcs in a box

Item 2418-120



Paint grid metallic
galvanised, dimension 26x30 cm

10 pcs in a box

Item 2421-260



Paint brush
17x7 cm

12 pcs in a box

Item 2401-170



Radiator brush
pure natural bristle

24 pcs in a box

Item	width
2400-050	50 mm
2400-075	75 mm



Plaster plane SHARK



Plaster plane toothed SHARK

extra sharp teeth,
stainless steel, 2K handle with thumb pressure point

Item	size
2054-290	290x150 mm
2054-325	325x150 mm

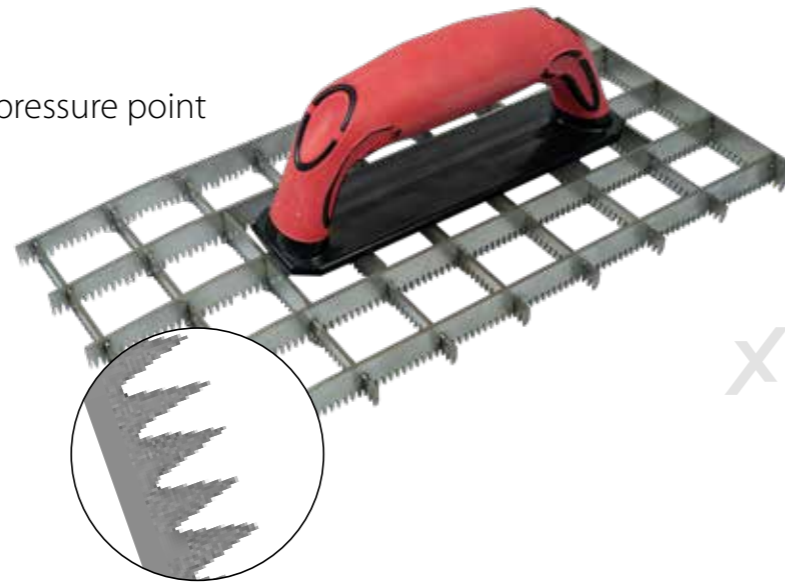

In a sales box for hanging up.

Tools and devices



Plaster planes

Plaster plane small,
2K-handle
dimension 280x140 mm,
reinforced version

30 pcs in a box

Item 2055-140

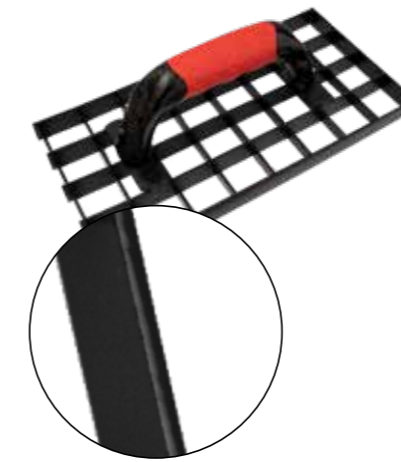

Aluminium plaster plane,
steel handle
dimension 450x85 mm,
reinforced version,
Made in EU

10 pcs in a box

Item 2050-450



Plaster plane small, serrated
size 280x140 mm

30 pcs in a box

Item 2053-140

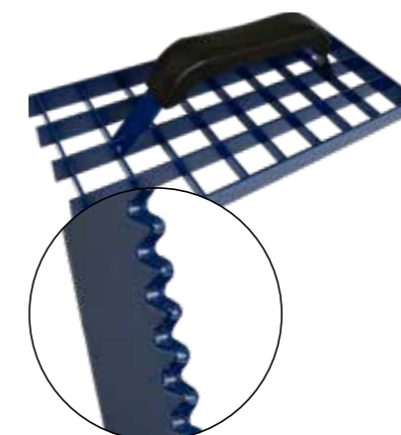

Plaster plane small, flat
size 280x140 mm

30 pcs in a box

Item 2052-140

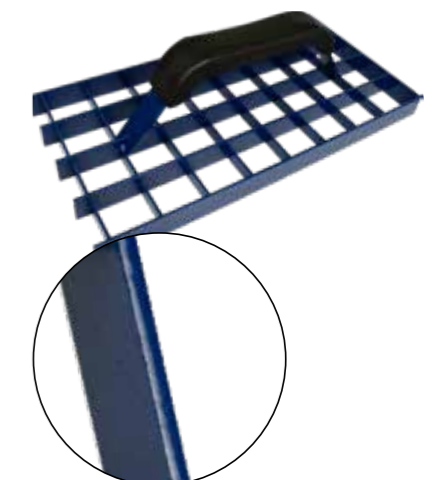

Tools and devices

Skimmer floats



Grinding tools and drywall tools

Skimmer float K16 with wooden handle with velcro
dimension 420x200 mm

12 pcs in a box

Item 2200-420

Replacement abrasive layer
dimension 420x200 mm

Item 2200-421



Skimmer float K16 with 2K-Handle with velcro
dimension 200x140 mm

20 pcs in a box

Item 2200-200

Replacement abrasive layer
dimension 200x140 mm

Item 2200-201



Skimmer float PVC with sheet plate
with PVC carrier board OPEN,
2K-handle, low-weight 660 g,
dimension 380x160 mm

10 pcs in a box

Item 2221-380



Skimmer float PVC with sheet plate
with PVC carrier board,
dimension 270x130 mm

25 pcs in a box

Item 2220-270



Skimmer float wood with sheet plate
with wooden supporting plate,
dimension 400x180 mm

12 pcs in a box

Item 2220-400



Hand grinder 200x100x25 mm
90° abent, grain size 24
grinds two sides simultaneously

12 pcs in a box

Item 2287-024



Plasterboard transporter
single axis, ultimate load 350 kg, 2 support wheels

Item 2463-000



Hand grinder 235x83 mm
plastic,
with strong foam rubber plate,
wing screw fastening

12 pcs in a box

Item 2230-000



Grinding mesh 280x85 mm

10 pcs in a box

Item	Granulation
2230-080	80
2230-100	100
2230-120	120



Compound pliers for C- and U-profiles
max. 0,8+0,8 mm, 345 mm

25 pcs in a box

Item 2454-345



Wall plane PREMIUM 250x42 mm
with metallic plane body

54 pcs in a box

Item 2231-001



Replacement blade for wall plane

12 pcs in a box

Item 2231-010



Round file, 2K-handle
pointed tip drill,
ideal for cutting of plaster boards
length 250 mm, diameter 6,5 mm

12 pcs in a box

Item 2453-000



Cutter knife 18 mm ALULOCK
selflocking,
extra strong version

12 pcs in a box

Item 2000-004



Cutter knife 18 mm PVC

48 pcs in a box

Item 2000-000



Cutter knife 18 mm PVC
with metallic blade guidance

36 pcs in a box

Item 2000-001



Segment blades 18 mm

10 pcs per quiver

Item	type
2000-002	universal
2000-003	Japanese steel
2005-001	BLACK STAR 0,6 mm



Nippon cutter 25 mm
with metallic blade guidance,
inkl. 10 replacement blades

10 pcs in a box

Item 2001-000



Segment blades PROFI 25 mm
0,7 mm

10 pcs per quiver

Item 2001-001



Serrated insulation knife
280 mm

10 pcs in a box

Item 2002-280



Serrated insulation knife
with serrated edge
420 mm,
with 2K-handle and Knife sheath

Item 2002-420



Stucco saw
with wooden handle

30 pcs in a box

Item 2052-320



Jig saw 150 mm
with wooden handle

12 pcs in a box

Item 2092-150



hand saw small 300 mm
with wooden handle

12 pcs in a box

Item 2092-300



hand saw 400 mm
with wooden handle

10 pcs in a box

Item 2090-450



Battery power scissors

Li-Ion 3,6 V, 1,5 Ah, working time approx 1 hour,
charging time 2-3 hours
incl. spare cutting head and charger

Cuts almost all materials such as fleece, fabric,
decoupling mats, wallpaper, leather, etc.

5 pcs in a box

Item 2071-250



Item 2075-010 Ersatzschneidekopf

Bevelling shears ECO 220 mm
with angle meter, stop bar and
removeable blades

Item 2079-220



Bevelling shears EDMA 240 mm
with angle meter and
removeable blades

Item 2079-240



Replacement blades
for bevelling shears
suitable for 2079-220 and 2079-240

10 pcs per quiver, 10 quivers in a box

Item 2079-241



Leverage metal shear 250 mm
universal, hardened tp 60-62 HRC

5 pcs in a box

Item 2071-250



Leverage metal shear 250 mm
right, hardened to 60-62 HRC

5 pcs in a box

Item 2072-250



Leverage metal shear 250 mm
left, hardened to 60-62 HRC

5 pcs in a box

Item 2073-250



Floor scrapers, tackers and staples

Floor scraper with handle

1,5 mm spring steel,
width 300 mm, with bar

Item 2990-302



Floor scraper

1,5 mm spring steel,
width 300 mm, without bar

packaging unit 5 pcs

Item 2990-300



Replacement sheet for floor scraper

1,5 mm spring steel,
width 300 mm

Item 2990-303



Hammer tacker type 11 for staples 6-10 mm

Item 2081-010

Hammer tacker type 11 for staples 6-14 mm, with metal sledge

Item 2081-014



Staples type 53

2000 pcs in a box

Item dimension

2080-006 6 mm
2080-008 8 mm



Staple gun type 53 for Staples to 10 mm

10 pcs in a box

Item 2080-000



Floor scraper

1,5 mm spring steel,
with bar

packaging unit 5 pcs

Item width

2990-301 300 mm
2990-500 500 mm



Handle for floor scraper wood, 140 cm

Item 2990-130



Staples type 11

5000 pcs in a box

Item dimension

2082-010 10 mm
2082-014 14 mm



Handmixer EV 40

230 V, 1600 Watt, 0-430/760 rpm,
M14 holder with 140 mm stirring rod,
large ergonomic handle with easily accessible
operating elements

For liquid and powdery mixing materials with a heavy consistency:
e.g. paints, varnishes, fillers, cement, plaster, lime, concrete, screed etc.

Soft start and 2-speed gearbox with infinitely variable speed control

Over 10.000 units already sold.

Item 5200-040



Stirring rod

M14 thread, spiral left side, MK 140 mm

Item 5230-140



Mortar trough round

100 pcs on a pallet

Item volume

2851-065 65 liter
2851-090 90 liter



Mixer and buckets

Mortar trough angular 65 liter

210 pcs on a pallet

Item 2850-065



Construction bucket with handle

Item	volume	pallet
2852-012	12 liter	550 pcs
2852-020	20 liter	480 pcs



Foam gun with threaded tip



General construction tools

Foam gun with threaded tip

high-quality, robust metal gun with 2K handle, ergonomic and rubberised 2K handle, PTFE non-stick coated tip

stable single-carton, 20 pcs in a big box

Item. 2810-010



Dosing needle

length 300 mm, inner diameter 3 mm, outer diameter 4 mm

To fill spaces with PU foam that are not accessible without a needle. With the dosing needle you can reach the smallest grooves and the furthest corners. Even overhead work is no longer a problem. If necessary, the needle can be curved once and shortened with a metal saw.

Item. 2810-200



Fill gap completely Spray out breakthroughs fix insulation boards Backfilling window sills Work overhead



NBS foam gun ECO

with a plastic handle
robust carton packaging, 20 pcs in a big box

Item. 2810-000



Concrete binding wire

single, 1 mm
1000 pcs in a bundle

Item	length
2900-012	120 mm
2900-014	140 mm



Bricklayer cord

1,7 mm, 50 m, green-white
6 pcs in a box
Item 2970-050



NBS gun cleaner

500 ml, high-quality cold cleaner, removes fresh PU-foam dirt, also for the flushing of foam guns
12 cans in a box

Item 1812-500



Well wheel 190 mm

with safety bracket
Item 2990-190



Chalk liner aluminium

30 m
12 pcs in a box
Item 2970-030



Drilling accessory 30 cm

with long rubber handle, milled spindle
Item 2900-020



Hand driven lift rope 18 mm, 25 m well wheel

made of polypropylen with safety carabiner, 150 kg
Item 2990-144



Coloured powder red

200g can
12 pcs in a box
Item 2970-200



Tools and devices

Tools and devices

Tool and nail bag nylon with 8 pockets

12 pcs in a box

Item 2490-002



Belt nylon with extra strong buckle

12 pcs in a box

Item 2490-010



Measuring tape housing made of impact-resistant plastic, class 2

Item	length	width
2570-003	3 m	16 mm
2570-005	5 m	18 mm



Stonemason hammer with wooden handle, 1 kg

6 pcs in a box

Item 2910-004



Lath hatchet with steel tube handle

6 pcs in a box

Item 2910-001



Bricklayer hammer with steel tube handle

6 pcs in a box

Item 2910-002



Lath hammer with steel tube handle

6 pcs in a box

Item 2910-003



LED Floodlight SLIM

230 V, steelframe, 5 m cable, illuminant, IP65 splash water proof, shock-resistant, Chip Made in Taiwan, life time of the chip around 30.000 hours, attractive carton packaging, 2 years guarantee on the illuminant

Item	Watt	Lumen	pallet
3036-050	50	4.300	48 pcs
3036-100	100	8.300	32 pcs
3036-150	150	12.000	32 pcs



Professional tripod XL

height 260 cm, strengthened telescope fixing, galvanised

Item 3080-280



Tripod adapter with thread for TRIPLEX

for the installation upside down

Item 3080-000



TRIPLEX LED 360° Floodlight

attractive carton packaging, 1 year guarantee on the illuminant

- 8400 Lumen
- 6500 Kelvin
- 120 W / 230 V
- 360° light
- IP54 protection class
- 5 m cable H07RN-F 3G1.5
- weight 3,6 kg
- shock-proof and vibration-proof
- diameter 349 mm
- height with handle 436 mm
- operating temperature max. 48° C with 23° C room temperature
- lamp body made of impact-resistant polycarbonat
- 28 mm tripod connection, with fixing screw at the bottom

30 pcs per pallet

Item 3060-120



Styrofoam cutters



Styrofoam cutter POWERCUT XXL

for the fast cutting of styrofoam and XPS,
cutting length 132 cm, cutting depth 30 cm,
Transformer 40 V / 200 W, weight 11 kg, ruler 103 cm

included: 1 replacement wire, spring compressor

Item 5100-805



Transport bag PVC for POWERCUT XXL

with velcro strap and small wire bag inside, weight 13,7 kg

Item 5110-009



Replacement cutting wire for POWERCUT XXL

with 2 eyelets complete assembled, strength 0,55 mm, wire length 140 cm

Item 4950-101



Transformer 200 W for POWERCUT XXL

AC adapter 40 V - 5 A with cable and plug

Item 4950-115



Scaffolding clamp for POWERCUT XXL

Item 5110-003



Stand set for POWERCUT XXL

incl. scaffolding clamp (essential), retractable without any tools

Item 5110-001



Stand ECO for POWERCUT XXL

retractable without any tools

Item 5110-000



Styrofoam cutters

Styrofoam cutter POWERCUT VARIO XXL

For the professional cutting of insulation boards made of Styrofoam/ Polystyrene,
extendable handle, cutting length 81-137 cm, cutting depth 33 cm,
Transformer 42 V / 240 W, weight 14,5 kg,
with slope cutting device,
highly suitable for 100x100cm insulation boards

The wire is fastened by means of a clamping roller, to be able to adjust the length continuously and flexible.
Thanks to the long support ruler (81cm left side and 91cm right side) and the depth stop, an exact cutting is guaranteed.

An electronic transformer ensures a constant power supply, even when working with different wire lengths.

incl. PVC case with velcro belts, small bag (for wires) and footswitch

Item 5100-850

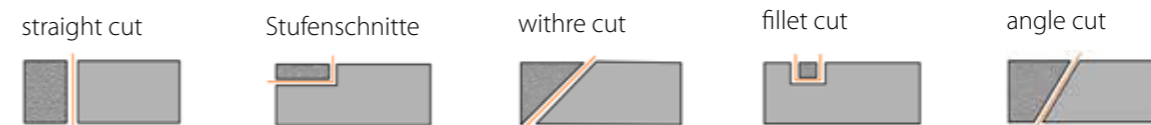

Verti-Cutter for POWERCUT VARIO XXL

Enables various bevel- and withre cuts, incl. transformer

Item 5100-860



Transformer for POWERCUT VARIO XXL

Item 4950-150



Winding handwheel for POWERCUT VARIO XXL

incl. 2 m wire

Item 4950-103



Replacement cutting wire for POWERCUT VARIO XXL

20 m roll, thickness 0,55 mm

Item 4950-102



Cutting wires and hand cutter



Replacement cutting wires

with 2 eyelets complete assembled, thickness 0,55 mm

Item	suitable for	wire length
4950-100	POWERCUT 102 XL	110 cm
4950-109	POWERCUT ALU XXL, Maxima Pro Uno	138 cm
4950-101	POWERCUT 132 XXL	140 cm
4950-108	ECO 135, Profi 135, POWERCUT ALU XXL	151 cm



POWERCUT 200

powerful device for the building trade

- adjustable
- up to 200 mm board thickness
- 190 Watt
- 3 m cable

incl. transport case,
1 blade 200 mm and wire brush

Item 5101-320



Blade small for POWERCUT 200

length 200 mm

Item 4950-200



Insulation cutter

Insulation cutter

for cutting hemp, wood fibre boards, glass wool, rock wool and much more,
Lightweight, robust aluminium construction,
rulers (left 96 cm, right 96 cm)

- cutting guide can be continuously swivelled from 0° - 90
- wall bracket can be folded out
- integrated feet can be set up without tools
- adjustable clamping device
- cutting depth 0-240 mm
- cutting length 150 cm
- weight 11.3 kg

including 42 cm insulation blade

Item 5104-150



NOTE: Insulation knives can be found on page 150.

Battery reciprocating saw CROCO

14,4 Volt, LI-ion battery 1,5 Ah,
cutting depth 300 mm, length 34 cm

incl. saw blade 340 mm, 2 batteries
and transport case

Item 5104-144



Battery for
reciprocating saw CROCO
14,4 Volt, LI-ion battery 1,5 Ah,

Item 5104-145



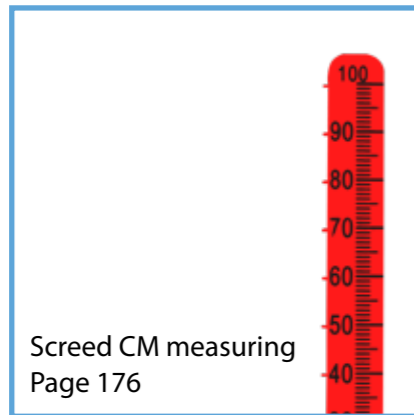
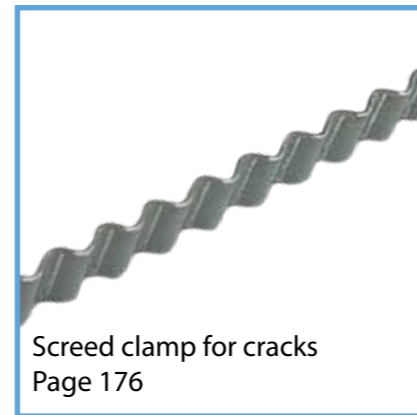

Building materials

162-181

Fiberglass mesh	164
Insulations anchors and anchor discs	165
Window beads	166
ETICS profiles and accessories	167
Wire corners	170
Plaster profiles	171
Construction chemistry	172
Drywall profiles	173
Screed anchor, screed clamp, screed accessories	176
Constructions foils and vapor barrier foils	177
Masking tapes	178
Masking fleece and masking paper	180
General building materials and garbage bags	181

Note:
The lengths of items 1180, 1181, 1185 and 1187 (window beads)
have been adjusted from 240 cm to 260 cm due to market requirements.

All products labelled with X are from our own production
or are produced exclusively for us according to our specifications.

Fiberglass mesh



Insulations anchors and anchor discs

ETICS Fiberglass mesh SGG 02

4x5 mm, 145 g/m², width 100 cm, ETAG 004 certified, dimensionally stable, alkali-resistant, non-slip, do not rot tensile strenght warp and filling > 2000 N

50 m² per roll, 33 rolls per pallet

Item	colour
1302-050	white
1303-050	orange



Fiberglass mesh SGG 22 universal

10x10 mm, 145 g/m², width 100 cm, blue

50 m² per roll, 24 rolls per pallet

Item 1311-050



Fiberglass mesh SGG 07 Putz light

7x7 mm, 105 g/m², width 100 cm, white, Made in Europe

100 m² per roll, 15 rolls per pallet

Item 1315-100



ETICS Fiberglass mesh SGG 01

4x5 mm, 160 g/m², width 100 cm, white, ETAG 004 certified, alkali-resistant, non-slip, do not rot tensile strenght warp and filling > 2000 N

50 m² per roll, 30 rolls per pallet

Item 1304-050



Fiberglass mesh SGG 07 heavy

7x7 mm, 160 g/m², width 100 cm, white

50 m² per roll, 33 rolls per pallet

Item 1313-050



Fiberglass mesh SGG 75 ight

5x5 mm, 75 g/m², width 100 cm, white

50 m² per roll, 60 rolls per pallet

Item 1314-050



ETICS nailed-in anchor 10/60 mm

with fiberglass reinforced plastic nail, anchoring depth 25 mm, not pre-assembled, suitable for class A, B, C, D, E

250 pcs in a box

Item	length
1700-090	90 mm
1700-120	120 mm
1700-140	140 mm
1700-160	160 mm
1700-180	180 mm
1700-200	200 mm



ETICS nailed-in anchor 8/60 mm

with steel nail, anchoring depth 25 mm, ETAG certified, suitable for class A, B, C, D

200 pcs in a box

Item	length
1750-095	95 mm
1750-115	115 mm



ETICS nailed-in anchor 8/60 mm

with steel nail, anchoring depth 25 mm, ETAG certified, suitable for class A, B, C, D, E

200 pcs in a box

Item	length
1750-135	135 mm
1750-155	155 mm
1750-175	175 mm
1750-195	195 mm

100 pcs in a box

1750-215	215 mm
1750-235	235 mm
1750-255	255 mm
1750-275	275 mm
1750-295	295 mm



Anchor disc 60 mm

without screw, with cover, for max. 5 mm screws

200 pcs in a box / 56 boxes per pallet

Item 1710-060



Window beads



Reveal bead with lip
for inside and outside,
3 mm foam strip, length 260 cm

30 pcs / 78 m in a box

Item	width
1183-260	9 mm
1183-256	6 mm



Reveal bead with lip/flexible
for inside and outside,
10 mm foam strip,
length 260 cm

30 pcs / 78 m in a box

Item 1182-260

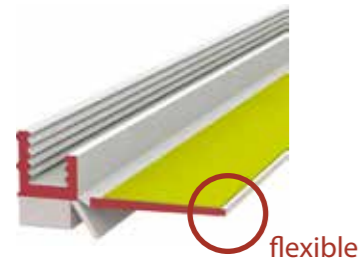

Membrane bead Maxiflex AIR multi-part 3D
red foam, with plastering bracket,
wet plaster inside, movement absorption > 4 mm,
length 260 cm

60 pcs / 156 m in a box

Item 1190-260



Reveal bead
for inside and outside,
3 mm foam strip, length 260 cm

30 pcs / 78 m in a box, 98 boxes per pallet

Item	width
1180-260	9 mm
1181-260	6 mm

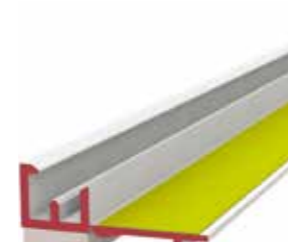

Reveal bead with lip/flexible with plastering bracket
for inside and outside,
10 mm foam strip,
length 260 cm

30 pcs / 78 m in a box

Item 1183-267

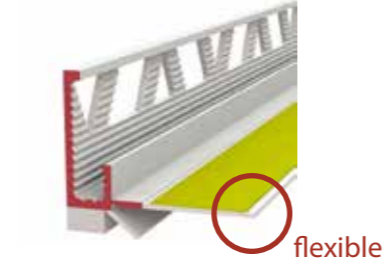

Membrane bead Maxiflex RAIN multi-part 3D
green foam, with plastering bracket,
wet plaster outside, movement absorption > 4 mm,
length 260 cm

60 pcs / 156 m in a box

Item 1191-260

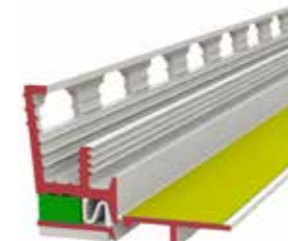

ETICS reveal bead with lip
with 12,5 cm mesh, 3 mm foam strip,
length 260 cm

30 pcs / 78 m in a box

Item	width
1186-261	9 mm
1186-262	6 mm



ETICS connection bead for roller shutter guide
with 12,5 cm mesh, 3 mm foam strip,
length 260 cm

25 pcs / 65 m in a box

Item 1189-260



Window beads ETICS

ETICS reveal bead
with 10 cm mesh, 3 mm foam strip,
length 260 cm

30 pcs / 78 m in a box

Item	width
1185-260	9 mm
1187-260	6 mm



Membrane bead Maxiflex RAIN with mesh multi-part 3D
green foam, ETICS outside,
movement absorption > 4 mm,
length 260 cm

60 pcs / 156 m in a box

Item 1192-260



PVC corner bead

with 10x 15 cm mesh,
length 250 cm

50 pcs / 125 m in a box,
45 boxes per pallet

Item color mesh

1100-125 white
1100-126 orange

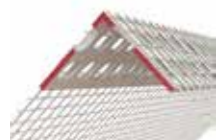

PVC driptnose reinforced

with 10x10 cm mesh,
totally plasterable, length 250 cm

10 pcs / 25 m in a box,
52 boxes per pallet

Item 1110-250

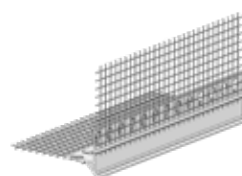

PVC insert socle profile

with 12,5 cm mesh strip,
length 250 cm

25 pcs / 62,5 m in a box

Item insert depth

1140-250 10 cm (8 cm)
1140-251 5 cm



Rollfix VARIO

flexible corner on a roll,
with 12,5x12,5 cm mesh,
25 m, from 45° to 150° usable,
no cutting scrap

Item 1109-025



PVC driptnose ECO

with 10x10 cm mesh,
totally plasterable,
length 250 cm

20 pcs / 50 m in a box

Item 1113-250



Connecting bead L

with 8 cm mesh,
for accurately connections, edging etc.,
length 200 cm

25 pcs / 50 m in a box

Item plaster thickness

1124-200 3 mm
1125-200 6 mm



Attikaprofile with mesh

length 250 cm

25 pcs / 62,5 m in a box

Item 1128-250



Roof ventilation PVC

length 250 cm

25 pcs / 62,5 m in a box

Item 1173-250



Sheet steel connecting bead

maintenance-free, movable and
waterproof connection,
ETICS/sheet metal,
length 250 cm

25 pcs / 62,5 m in a box

Item 1123-250



Expansion joint bead TPE
for little building element
movements inside and outside,
length 250 cm

25 pcs / 62,5 m in a box

Item 1122-250



Primer stick 150

for the preparation of
substrates that are difficult to bond,
improves the bonding of
plastering and sealing strips

10 pcs in a box

Item 1199-150



Mounting roller (Pressure roller) with 2K-handle

for a proper assembly of reveal and
membrane beads, made of steel, 30 mm
smooth-running brass wheel,
suitable for right and left-handed users,
3 mm groove

Item 2079-300



Citrus cleaner

400 ml, organic all-purpose cleaner,
can be used on nearly all surfaces,
glue residues can be removed
easily, fresh citrus fragrance

12 tins in a box

Item 2880-400



Wire angles



Wire angle APS

60x60 mm side length,
length 295 cm, plaster thickness 15 mm

40 pcs / 118 m in a box
40 boxes on a pallet

Item 1091-295



Wire angle APE

stainless steel,
60x60 mm side length,
length 295 cm, plaster thickness 15 mm

40 pcs / 118 m in a box
40 boxes on a pallet

Item 1094-295



Wire angle APA

not equal-sided,
60x30 mm side length,
length 295 cm, plaster thickness 15 mm

40 pcs / 118 m in a box
40 boxes on a pallet

Item 1092-295



Wire angle APBK

arched type PVC,
60x60 mm side length,
length 295 cm, plaster thickness 15 mm

33 pcs / 97,35 m in a box
40 boxes on a pallet

Item 1097-295



Corner bead galvanised sheet steel

34x34 mm, steel thickness 0,5 mm,
plaster thickness 10 mm

25 pcs per bundle / 75 bundle per pallet

Item	length	bundle
------	--------	--------

1000-160	160 cm	40 m
1000-200	200 cm	50 m
1000-225	225 cm	56,25 m
1000-250	250 cm	62,50 m
1000-260	260 cm	65 m
1000-275	275 cm	68,75 m
1000-300	300 cm	75 m



Plaster deviding and stop bead

galvanised sheet steel, length 300 cm

25 pcs / 75 m per bundle

Item	plaster thckn.
------	----------------

1009-300	9 mm
1014-300	14 mm

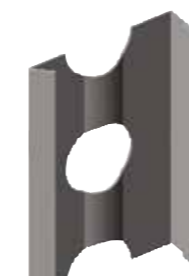

Plaster profiles

Depth gauge bead galvanised sheet steel

50 pcs per bundle

Item	plaster thckn.	length	bundle
------	----------------	--------	--------

1001-250	6 mm	250 cm	125 m
1002-250	10 mm	250 cm	125 m
1002-260	10 mm	260 cm	130 m
1002-275	10 mm	275 cm	137,5 m



Socle stop profile

110° with PVC drip nose,
galvanised sheet steel, length 300 cm

25 pcs / 75 m per bundle

Item	plaster thickness
------	-------------------

1060-300	10 mm
1061-300	14 mm
1062-300	20 mm



Adhesion promoter for concrete (Betonkontakt) PREMIUM

red colored adhesive bridge for plaster and adhesive binders on smooth concrete surfaces, creates a sufficiently handlepy area for plastering work, applicable indoor and outdoor, consumption approx ca. 200 g/m²

23 kg per bucket / 24 buckets per pallet

Item 1800-023



Adhesion promoter for concrete (Betonkontakt) SMART

red colored adhesive bridge for plaster and adhesive binders on smooth concrete surfaces, creates a sufficiently handlepy area for plastering work, applicable indoor and outdoor, consumption approx ca. 150-250 g/m²

23 kg per bucket / 24 buckets per pallet

Item 1801-023



Absorption barrier PE 74

to create equally absorbent plaster bases, not film-forming, concentrate for inside and outside, depending on application up to 1:10 dilutable, consumption approx ca. 20-50 g/m²

25 kg per canister / 28 canister per pallet

Item 1802-026



Primer

solvent-free primer for highly sucking surfaces, applicable indoor and outdoor

18 kg per bucket / 24 buckets per pallet

Item 1802-018



Aluminium coner bead 24x24 mm 90°

plate thickness 0,3 mm, plaster thickness 1 mm

50 pcs per bundle / 4 bundles in a box
160 bundles per pallet

Item	length	bundle
1200-250	250 cm	125 m
1200-260	260 cm	130 m
1200-275	275 cm	137,5 m
1200-300	300 cm	150 m

roughened/perforate type

plate thickness 0,3 mm

Item	length	bundle
1207-250	250 cm	125 m
1207-275	275 cm	137,5 m



Aluminium coner bead 24x24 mm 135°

plate thickness 0,3 mm, plaster thickness 1 mm, length 300 cm

50 pcs / 150 m per bundle, 4 bundles in a box

Item 1202-300



Aluminium coner bead 24x12 mm 90°

Lichtenstein profile, plate thickness 0,3 mm, plaster thickness 1 mm

50 pcs per bundle / 4 bundles in a box
160 bundles per pallet

Item	length	bundle
1201-250	250 cm	125 m
1201-275	275 cm	137,5 m
1201-300	300 cm	150 m



PVC arch corner bead 23x23 mm

from a radius of 250 mm, plaster thickness 3 mm, length 300 cm

50 pcs / 150 m in a box

Item 1204-300



Drywall profiles



Profile for clipping on plaster boards, with self-adhesive foam strip

the fast moveable connection to other components, additional with lip and 12,5 mm foam strip, plate thickness 12,5 mm, length 250 cm

50 pcs / 125 m in a box

Item 1209-250



Profile for clipping on plaster boards, with self-adhesive foam strip

the fast moveable connection to other components, with 12x2 mm foam strip, plate thickness 12,5 mm length 300 cm

50 pcs / 150 m in a box

Item 1209-300



Profile for clipping on plaster boards white coated steel

25 pcs in a box

Item	thickness	length	bundle
1216-250	12,5 mm	250 cm	62,5 m
1216-300	12,5 mm	300 cm	75 m
1217-250	15 mm	250 cm	62,5 m



Profile for clipping on plaster boards PVC white

length 300 cm

50 pcs / 150 m in a box

Item thickness

1212-300	12,5 mm
1213-300	15 mm

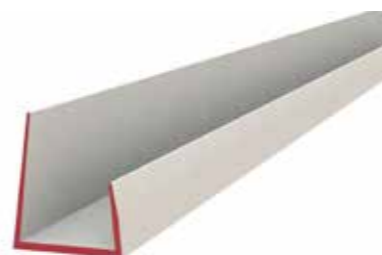

Stop bead for plasterboards galvanised steel

length 300 cm

25 pcs / 75 m per bundle

Item thickness (A)

1219-300	12,5 mm
1218-300	15 mm



Shadow joint profile galvanised steel

length 300 cm, thickness (A) 12,5 mm

15 pcs per bundle

Item shadow joint

1220-250	4 mm (250 cm)
1220-300	4 mm
1221-300	10 mm
1222-300	15 mm
1223-300	20 mm



PVC stop bead with shadow joint

length 300 cm

35 pcs / 105 m in a box

Item 1232-300



PVC angle bead

for arched connections, convex and concave applicable, length 250 cm

10 pcs / 25 m in a box

Item 1230-250



Shadow joint profile galvanised steel

length 300 cm, thickness (A) 15 mm

15 pcs per bundle

1225-300	4 mm
1226-300	10 mm
1227-300	15 mm
1228-300	20 mm



PVC movement joint bead with flexible TPE middle part, on a roll

Item length

1233-025	25 m
1233-075	75 m



Drywall profiles

Shadow joint profile steel white coated

length 300 cm, thickness (A) 12,5 mm, shadow joint 10 mm

15 pcs per bundle

Item 1229-300



PVC-Lichtenstein profile for arched constructions, length 300 cm

50 pcs / 150 m in a box

Item 1234-300



Screed joint anchor

4 mm steel core, 0.3 mm PVC jacket, round, double-sided sliding sleeves optimally absorb movements of the screed, 100% protection against height offset, can also be used with floating screed

length 300 mm

250 pcs in a box

Item 1479-004



Screed clamp for cracks

width 6 mm, thickness 0,5 mm, wave height 1,9 mm, wave spacing 4,5 mm

1000 pcs (10 bags) in a box

Item length

1475-070	70 mm
1475-120	120 mm

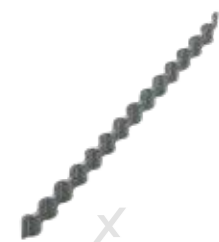

Screed CM measuring piece 13,6 cm

self-adhesive, 10 cm scale, length 13,6 cm

100 pcs per bag, 10 bags in a box

Item 1472-002



Screed CM measuring piece 10,7 cm

self-adhesive, 10 cm scale

100 pcs per bag, 10 bags in a box

Item 1472-003

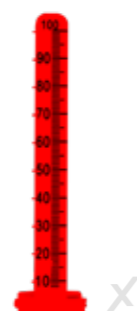

Screed glassfibers

to prevent shrinkage cracks dosage from 1-3 kg/m³

Item length bag pallet

1480-006	6 mm	1 kg	900 kg
1480-012	12 mm	20 kg	500 kg



L-shaped angle 50/70

waterproof coated carton, thickness 3 mm, length 220 cm

25 pcs / 55 m per bundle
1650 pcs per pallet

Item 1470-220



Screed expansion joint 10x80 mm

socket 45 mm, self-adhesive, length 200 cm

12 pcs in a box

Item 1471-080



PE construction foil OPAK dark

length 50 m

width 200 cm, 1x folded

Item type thckn. weight pallet

1510-050	100	50 my	4,58 kg	135 rolls
1510-100	200	100 my	8,68 kg	76 rolls



Scaffold foil

flat under the scaffold, to protect the underground (natural stone etc.) length 50 m, width 125 cm, thickness 200 my

62,5 m² per roll, 52 rolls per pallet

Item 1591-125



Self-adhesive tape blue for screed vapour barrier

extra long roll, blue, length 100 m, width 50 mm

36 rolls in a box

Item 1550-050



PE construction foil translucent

length 50 m

width 200 cm, 1x folded

Item type thckn. weight pallet

1500-035	50	30 my	2,94 kg	216 rolls
1500-050	100	50 my	4,58 kg	135 rolls
1500-100	200	100 my	8,68 kg	76 rolls
1500-120	200	120 my	10,42 kg	76 rolls

width 400 cm, 2x folded

1520-050	100	50 my	16,35 kg	85 rolls
1520-100	200	100 my	32,68 kg	44 rolls



Vapour barrier foil blue

50 m per roll

SD-value > 100 m

Item width thickness roll pallet

1550-100	200 cm	160 my	100 m ²	58 rolls
----------	--------	--------	--------------------	----------

SD-value > 148 m

1550-150	150 cm flat	200 my	75 m ²	60 rolls
1550-200	200 cm	200 my	100 m ²	52 rolls



Masking tapes



Adhesive tape WASHI GOLD

with 7 my HDPE special foil, for quick masking

Item	width	length	tape	box
1630-055	55 cm	25 m	15 mm	70 rolls
1630-140	140 cm	25 m	19 mm	35 rolls
1630-270	270 cm	16 m	19 mm	30 rolls



UV fabric adhesive tape with foil PROFI XXL

extra-wide adhesive tape with strong foil, for quick masking, 14 days UV-resistant, blue, tape 30 mm, width foil 18 my

Item	width	length	box
1620-055	55 cm	20 m	30 rolls
1620-140	140 cm	20 m	20 rolls
1620-270	270 cm	16 m	20 rolls



UV fabric adhesive tape with foil PROFI

with strong foil, 14 days UV-resistant, for quick masking, tape 18 mm, width foil 7 my, blue, length 20 m

Item	width	box
1621-055	55 cm	60 rolls
1621-110	110 cm	30 rolls



UV fabric adhesive tape blue

easy break off, no extension, 14 days UV-resistant, good adhesive strength, blue, length 25 m

Item	width	box
1671-038	38 mm	32 rolls
1671-050	50 mm	24 rolls



Fabric adhesive tape PROFI

for stone, plaster and cement, adapts to the ground, silver, length 50 m, width 50 mm

24 rolls in a box

Item 1670-050



Fabric adhesive tape

for stone, plaster and cement, adapts to the ground, extremely high adhesive strength also on wet underground, yellow, length 50 m, width 44 mm

16 rolls in a box

Item 1672-044



Fabric masking tape EASY CUT, flat

advantages of paper tapes and PVC tapes: easy to tear off, no stretching, 14 days UV-resistant, very high adhesive strength, PVC-free carrier material, white, length 33 m, width 48 mm

18 rolls in a box

Item 1605-050



Masking tape WASHI GOLD

very thin and smooth paper for extremely flat colour edges, length 50 m

Item	width	box
1653-030	30 mm	32 rolls
1653-038	38 mm	24 rolls
1653-050	50 mm	24 rolls



Paper masking tape PROFI 80°

yellow, length 50 m

Item	width	box
1650-030	30 mm	30 rolls
1650-050	50 mm	18 rolls



Masking tapes

Masking fleece
multiple useable,
with foil on the bottom side, grey
width 100 cm

50 m / 50 m² per roll

Item	weight approx	pallet
1590-050	180 g/m ²	24 rolls
1590-150	220 g/m ²	18 rolls
1590-250	270 g/m ²	14 rolls

10 m / 10 m² per roll / 15 rolls in a box

1590-010 180 g/m²



Masking fleece green Polyester
more tear-resistant thanks to tight weave,
with foil on the bottom side
width 100 cm

50 m / 50 m² per roll, 32 rolls per pallet

Item 1590-500



Masking fleece (for stairs) white
can be removed without any residues,
width 100 cm, weight approx 160 g/m²,
Made in EU!

50 m / 50 m² per roll, 24 rolls on a pallet

with self-adhesive fleece, foil on top

Item 1592-350



Masking paper
40 g natron paper,
for paintings and vanishing works

50 m per roll

Item	width	box
1690-150	150 mm	30 rolls
1690-300	300 mm	15 rolls



PE wall vapour protection
protects of humidity,
non-slip embossing on both sides
thickness approx 0,3 mm

50 m per roll

Item	width	roll	box
1593-013	13 cm	6,5 m ²	8 rolls
1593-029	29 cm	14,5 m ²	4 rolls
1593-034	34 cm	17 m ²	3 rolls
1593-042	42 cm	21 m ²	2 rolls
1593-054	54 cm	27 m ²	2 rolls



LDPE garbage bag / pallet cover
suitable as collection bag for polystyrene
waste, 2160 liter, thickness 80 my,
size 125x85x250 cm

20 bags in a box

Item. 1594-999



Rainwater gutter tube
protects the facade during renovation works,
length 150 m, thickness 100 my,
diameter 150 mm

Item 1570-150



Ceiling connection tape 3 mm
for crack prevention at plaster
connection,
with 10 mm adhesive strip,
length 30 m

Item	width	box
1825-030	30 mm	35 rolls
1825-050	50 mm	20 rolls



Garbage bag
on a roll, 240 liter,
thickness 65 my, size 100x125 cm

10 pcs on a roll / 8 rolls in a box

Item. 1594-240



Compressed tape 600, BG 1
for outside and inside sealing of
joints against driving rain and as
a soand and thermal insulation,
width 15 mm

32 rolls in a box

Item	joint	roll
1820-153	2-6 mm	12 m
1820-155	4-9 mm	8 m



Heavy goods garbage bag
translucent,
45 liter, thickness 120 my,
size 50x90 cm

10 pcs per bundle
10 bundles in a box

Item. 1594-010



General Terms and Conditions of Sale

General Terms and Conditions of Sale of the PET Austria GmbH

Deliveries are carried out by us only based on the following terms and conditions, which shall be deemed to have been accepted for the present transaction as well as for all further, including earlier, transactions when the order is placed. These Terms and Conditions are valid in so far as they are not changed by deviating written agreements. These General Terms and Conditions of Trade and Delivery shall also apply if the contracting partner communicates its own deviating Terms and Conditions, which we do not expressly object.

1. Prices

Unless otherwise agreed, the prices quoted are on the spot, net from our branches, excluding packaging and loading, packaging will be charged for at cost and will not be taken back. Price changes caused by circumstances over which the contractor has no influence, such as a price increase or price reduction by upstream suppliers, changes of law, official decrees, changes of collective agreement wages as well as price changes due to circumstances imposed by third parties occurring between the conclusion of the contract and delivery or invoicing, will be passed on to the contracting partner if there are more than two months between placing the order and delivery. This provision applies accordingly to fluctuations in currency exchange rates, increase and reduction in material costs based on recommendations of the Joint committee or due to changes (increase or decrease) in world market prices for raw materials, which have an impact on the materials used.

2. Delivery Time

2.1. Delivery dates stated by us are estimated delivery dates and non-binding. We can therefore not be held liable in any way for damages caused and loss of profit due to exceeding the delivery time. We are entitled to make partial and pre-deliveries. The transfer of risk and coincidence coincides with the handing over to the customer, the carrier or the forwarding agent, even if we have commissioned them with the delivery.

2.2. Goods ordered on "call-off" must be accepted within two months from the date of the order. After expiry of this period – or any shorter or longer period agreed in individual cases – we shall have the right, at our option, to deliver the goods or to withdraw from the contract and in any case to claim compensation for damage suffered and lost profit.

2.3. If the contracting partner is a consumer in terms of the KSchG (Austrian consumer protection act), paragraph 1 does not apply, but the contracting partner is entitled to withdraw from the contract if the delivery period exceeds 14 days. We are only liable for damages resulting from a possible delay in the event of gross negligence or intent, so that compensation for damages due to slight negligence is excluded.

3. Warranty

3.1. The warranty period for contracting partners who are entrepreneurs in terms of the UGB (Austrian commercial code) and other companies is six months and begins at the time of the transfer of risk.

Entrepreneurs are obliged to claim defects immediately by registered mail, otherwise their warranty and damage claims are forfeited. We are entitled to choose the warranty remedy (replacement, redhibition, improvement or price reduction). The occurrence of defects does not entitle to retain the purchase price or a part thereof unless the contracting partners are consumers in terms of the KSchG (Austrian consumer protection act).

3.2. The warranty period shall not be extended by a remedy of defects. The Seller shall never be liable for those goods or parts of goods which the Seller has obtained from suppliers to a greater extent than the Seller itself is entitled to warranty claims against the suppliers.

3.3. The warranty expires

3.3.1. if changes or modifications are made to the goods delivered by us by parties other than ourselves without our written consent,

3.3.2. if the agreed terms of payment are not met (deferral of payment does not change the loss of the warranty claim),

3.3.3. if the customer does not follow the regulations concerning the treatment of the object of purchase (operating instructions) and in particular does not have the required inspection carried out properly or

3.3.4. if the customer does not examine the ordered goods within 2 working days and does not inform us of any defects in writing (also by email or fax) within the same period. If no notification of defects is made within this period, all services to entrepreneurs shall be deemed checked, approved and handed over free of defects.

3.4. We are under no circumstances obliged to compensate for loss of profit and we are only obliged to pay other compensation if the damage was caused by us intentionally or through gross negligence.

3.5. The defective goods must be left in the same condition so they can be inspected by a representative appointed by us.

3.6. The shifting of the burden of proof in accordance with § 924 ABGB at our expense is excluded if the customer is an entrepreneur.

3.7. The warranty is excluded for used machines.

4. Payment

Payment of the purchase price shall be made as agreed or as stated on our invoice. Should payment dates be exceeded, default interest in accordance with § 1333 para. 2 ABGB (Austrian Civil Code) shall be deemed to have been agreed and we shall be entitled to postpone fulfillment of our own obligations until we receive the payments in arrears. In case of customer default, we are entitled to take back the goods to which we retain title until payment has been made in full, without this being equated to a withdrawal from the contract.

We are entitled to step back from accepting the order or request advance payment of the entire fee if, after placing the order, circumstances relating to the economic conditions of the customer become known through which our claim no longer appears to be sufficiently secured.

5. Set-off

Offsetting against our claims is not possible. If our business partner is a consumer in terms of the KSchG (Austrian Consumer Protection Act), offsetting against our claims is only permitted if the counterclaim is legally connected to the consumer's obligation and has been established by court or acknowledged by us in writing.

6. Retention of title

6.1. The goods shall remain our property until the purchase price, including any interest and collection costs, has been paid in full; in the case of payment by bill of exchange, the goods shall remain our property until the encashment of the bill of exchange. Retention of title shall also apply if the goods are not delivered directly by us but by a third party on our behalf. During this period the customer is therefore not entitled to transfer ownership of the goods to another third party, pledge them, offer them as security or otherwise transfer or process them. The customer is therefore obligated to notify us immediately by registered letter of any damage to the goods purchased, any attachment of these goods or any transfer of these goods and to do everything he is obliged to do as a diligent businessman or custodian so that we suffer no damage to our property.

6.2. If the customer sells or otherwise passes on goods subject to retention of title in the ordinary course of business, he hereby assigns to us by way of security all claims and accessory claims against third parties arising from such transactions. Upon request, the customer must inform us of his debtor and all information which we require to assert our claims and shall notify his debtor of the irrevocable assignment of claims. Our customer is authorised and obliged to collect the claims resulting from the resale for us as long as we do not make use of our right of direct collection.

7. Withdrawal from the contract

If there is no legal reason for withdrawal the revocation of the contract requires our written consent. In this case (if a contract is dissolved with our consent), we are entitled to demand 15% of the gross purchase price as contractual penalty, which is not subject to judicial mitigation. Any further claims remain unaffected and in place.

We are entitled to step back from accepting the order if, after placing the order and prior to delivery, circumstances relating to the economic conditions of the customer become known through which our claim no longer appears to be sufficiently secured and recoverable.

8. Choice of law

Austrian law shall apply under the exclusion of UN sales law. If our contractual partner is a foreign customer and if UN sales law would apply, it is mutually agreed that this is expressly excluded.

9. Place of jurisdiction

Pursuant to § 104 JN (Austrian Jurisdiction Act) it is agreed that the place of jurisdiction shall be the relevant competent court in Wels. Place of performance shall be our registered office.

10. Data protection

The customer consents that his personal and business data is electronically saved and processed by us and he agrees to receive information about new products and services by electronic mail and telecopies.

All statements are without guarantee, any offers are subject to change. Deviation from colors and types remain reserved.

We are not liable for printing or typesetting errors.



Check more about us!
Watch our company video here.



PET Austria GmbH

Solarstr. 16 | A-4653 Eberstalzell | +43 7241 28 3 28 | office@pet.co.at

www.pet.co.at